

Foras Multi-stage centrifugal pump cast iron 1 1/4" female thread 4,1A 230/400VAC blue type P7SV - 250/5T (0920431)



TECHNICAL SPECIFICATIONS

Colour	blue
Material	cast iron
Shaft	stainless steel 304
Pump body	cast iron
Material impeller 1	noryl
Connection	female thread
Voltage	230/400VAC
Max. temperature	35 °C
Minimum medium temperature (continuous)	5 °C
Press	1 1/4 "
Maximum ambient temperature	40 °C
Suction	1 1/4 "
Type	P7SV - 250/5T
Output Power	2,5 HP
Max. head	60,3 m
Material seal	ceramic/graphite

Size	1 1/4"
Seal	type M
Power	1.85 kW
Impellers	5
Ampere	4,1 A
Max flow rate	10.8 m ³ /h

DIMENSIONS

Cb-1	40 mm
Cb-2	202 mm
Cl-1	135 mm
G-1	125 mm
G-2	178.5 mm
H	473 mm
H-2	220 mm
L	229 mm
Lb	220 mm
O	11 mm
W-1	162 mm

W-2 204 mm

ØDi-1 1 1/4 "

ØDi-2 1 1/4 "

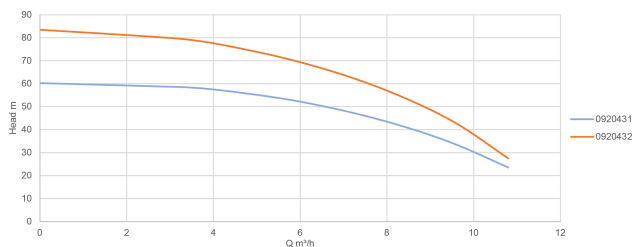
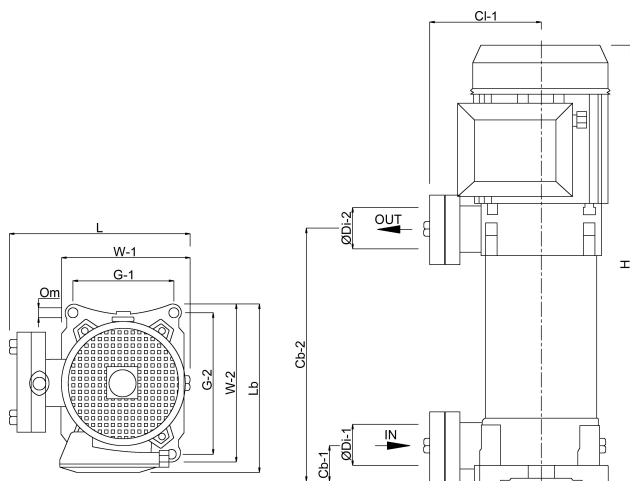

PRODUCT INFORMATION

Multistage vertical pumps. Pumping of clean non-loaded fluids in the domestic, agricultural and industrial sectors; pressurising systems; irrigation; drinking and glycol water; water treatment; food industry; heating and air conditioning; washing system.

Maximum liquid temperature: from - 15 to 90°C.

Ambient temperature: max 40°C.

Insulation class F; protection degree IP 44.

Supplied without cable.

Last modified date: 24/05/2026

Bosta UK Ltd.
Reflection House
Olding Road
Bury St. Edmunds
Suffolk

IP33 3TA
T +44 (0) 1284 716580
E enquiries@bosta.co.uk
<http://www.bosta.com>