

**Backing ring PP/steel PP 63
mm SDR11 16bar DN50 black
PN10/16 (0101933)**



TECHNICAL SPECIFICATIONS

Colour black

Material PP/steel

Surface treatment PP

Class SDR11

Pressure 16 bar

Size 63 mm

DN 50

Flange PN10/16

Outer ø 165 mm

Weight 0.789 kg

Thickness 18 mm

Bolt hole 18 mm

Holes 4

DIMENSIONS

O 18 mm

PCD 125 mm

ØDi-1

78 mm

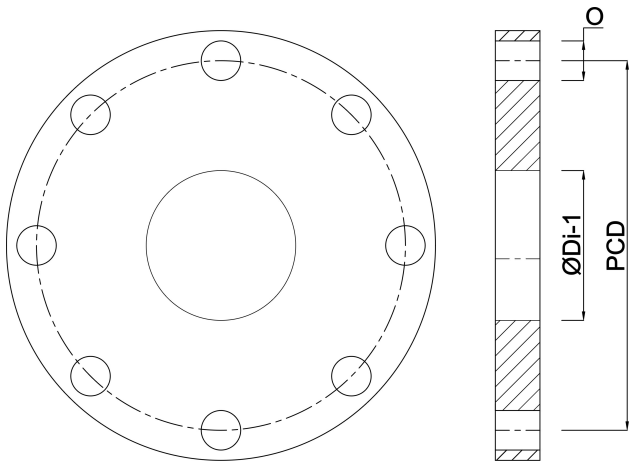

Last modified date: 22/05/2026

Bosta UK Ltd.
Reflection House
Olding Road
Bury St. Edmunds
Suffolk
IP33 3TA
T +44 (0) 1284 716580
E enquiries@bosta.co.uk
<http://www.bosta.com>