

Itap Ball valve brass nickel plated 3/8" female thread x male thread 50bar type 091 (0402332)

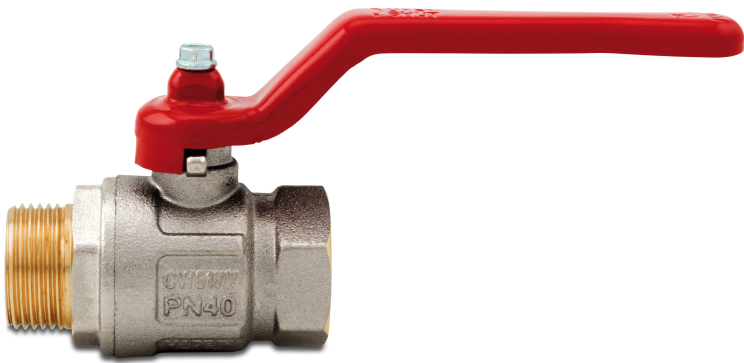

TECHNICAL SPECIFICATIONS

Type	091
Material	brass
Surface treatment	nickel plated
Operation	lever
Colour lever	red
Handle material	steel
Housing construction	2-part
Ball material	hard chrome plated brass
Material housing	brass
Material seal	PTFE
Connection	female thread x male thread
Max. temperature	150 °C
Minimum medium temperature (continuous)	-20 °C
Flow	full
Size	3/8"
Pressure	50 bar

DIMENSIONS

Ct-1 37 mm

F-1 10 mm

F-2 10.5 mm

Lb 54 mm

R 80 mm

ØDf 10 mm

ØDi-1 3/8 "

ØDo-2 3/8 "

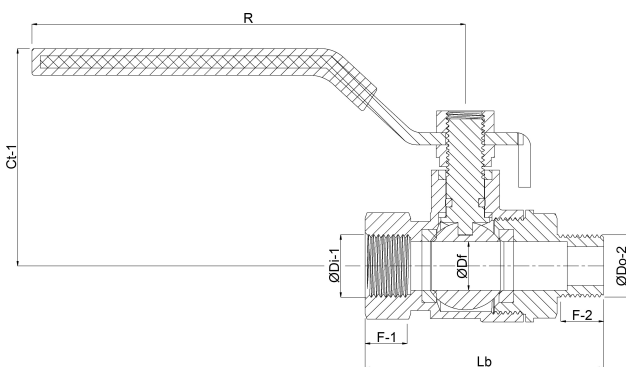

Last modified date: 23/05/2026

Bosta UK Ltd.
Reflection House
Olding Road
Bury St. Edmunds
Suffolk

IP33 3TA
T +44 (0) 1284 716580
E enquiries@bosta.co.uk
<http://www.bosta.com>