

**Profec Flange welding neck
steel DN50 x 60,3 mm DIN
flange x butt welding black
PN16 (1180480)**



TECHNICAL SPECIFICATIONS

Colour	black
Material	steel
Connection	DIN flange x butt welding
DIN Standard	DIN 2633
Flange	PN16
Size	DN50 x 60,3 mm
Outer ø	165 mm
Weight	2.48 kg
Height	45 mm
Thickness	18 mm
PCD	125 mm
Bolt hole	18 mm
Holes	4

DIMENSIONS

O	18 mm
PCD	125 mm

ØDi-1

54.5 mm

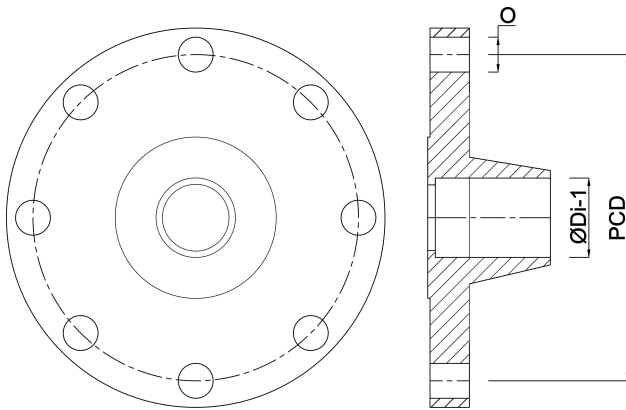

Last modified date: 24/05/2026

Bosta UK Ltd.
Reflection House
Olding Road
Bury St. Edmunds
Suffolk
IP33 3TA
T +44 (0) 1284 716580
E enquiries@bosta.co.uk
<http://www.bosta.com>