

**Backing ring PP/steel PP 225  
mm SDR11 16bar DN200 black  
PN10 (0101942)**



# TECHNICAL SPECIFICATIONS

Colour black

Material PP/steel

Surface treatment PP

Class SDR11

Pressure 16 bar

Size 225 mm

DN 200

Flange PN10

Outer ø 340 mm

Weight 2.68 kg

Thickness 25 mm

Bolt hole 22 mm

Holes 8

# DIMENSIONS

O 22 mm

PCD 295 mm

ØDi-1

238 mm

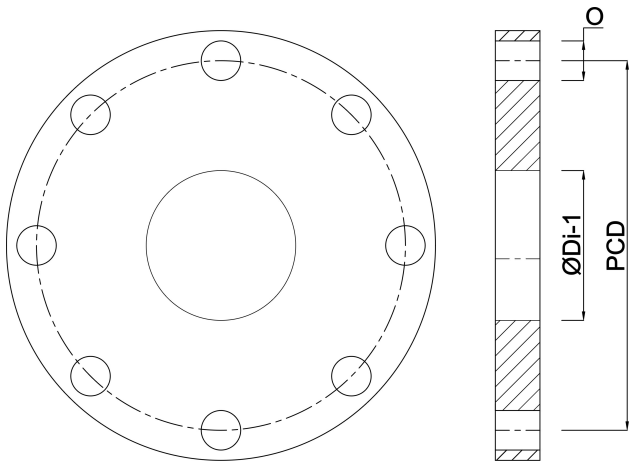

**Last modified date: 22/05/2026**

Bosta UK Ltd.  
Reflection House  
Olding Road  
Bury St. Edmunds  
Suffolk  
IP33 3TA  
T +44 (0) 1284 716580  
E [enquiries@bosta.co.uk](mailto:enquiries@bosta.co.uk)  
<http://www.bosta.com>