

VDL Flange adaptor PVC-U 125 mm glue socket 10bar DN100 grey PN10 type A (7018252)



VL Van de Lande

TECHNICAL SPECIFICATIONS

Colour grey

Material PVC-U

DIN Standard DIN 2501

Flange PN10

Pressure 10 bar

Type A

Size 125 mm

Connection glue socket

Packaging 8 pcs

DN 100

Outer ø 69 mm

Thickness 26 mm

Bolt hole 18 mm

Holes 8

DIMENSIONS

O 18 mm

PCD 190 mm

ØDi-1 125 mm

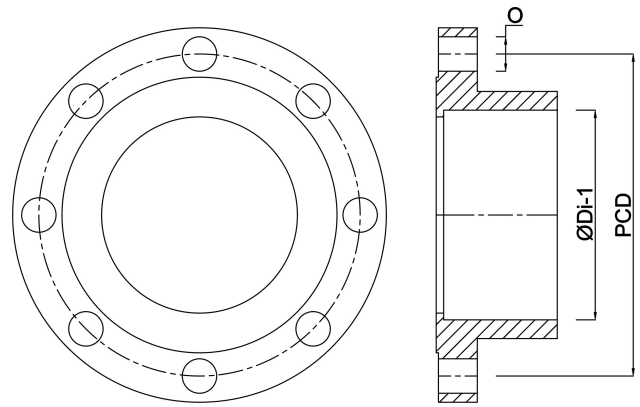

Last modified date: 24/05/2026

Bosta UK Ltd.
Reflection House
Olding Road
Bury St. Edmunds
Suffolk
IP33 3TA
T +44 (0) 1284 716580
E enquiries@bosta.co.uk
<http://www.bosta.com>