

Profec Ball valve PVC-U 40 mm glue socket 16bar DN32 grey type Safe 600 Viton (0112137)



TECHNICAL SPECIFICATIONS

Colour grey

Type Safe 600 Viton

Material PVC-U

Operation lever

Colour lever red

Handle material PVC-U

Housing construction 3-part

Material housing PVC-U

Material seal PTFE/viton

Connection glue socket

Max. temperature 60 °C

Minimum medium temperature 0 °C
(continuous)

Pressure 16 bar

Size 40 mm

DN 32

DIMENSIONS

Ct-1 93 mm

Lb 149 mm

R 65 mm

ØDf 32 mm

ØDi-1 40 mm

ØDi-2 40 mm

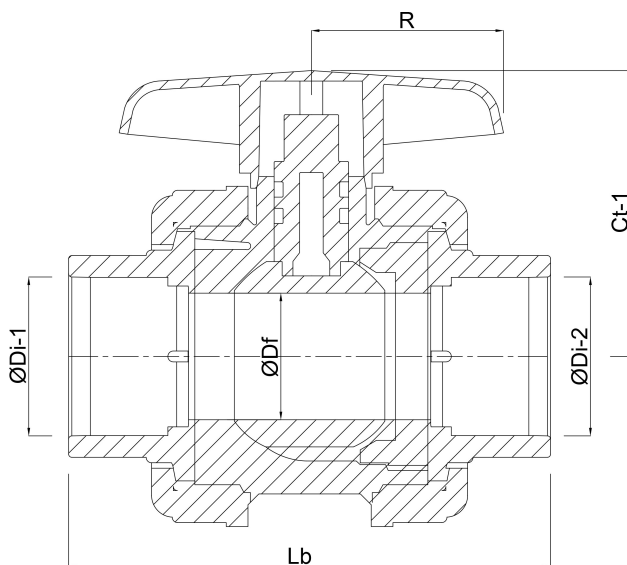

PRODUCT INFORMATION

With secure ball.

Last modified date: 23/05/2026

Bosta UK Ltd.
Reflection House
Olding Road
Bury St. Edmunds
Suffolk
IP33 3TA
T +44 (0) 1284 716580
E enquiries@bosta.co.uk
<http://www.bosta.com>