

**Itap Ball valve brass nickel  
plated 3/8" female thread x  
male thread 5bar DN10 DVGW  
type 067 (0401161)**



# TECHNICAL SPECIFICATIONS

Type	067
Material	brass
Surface treatment	nickel plated
Approval	DVGW
Operation	lever
Colour lever	yellow
Handle material	steel
Housing construction	2-part
Ball material	hard chrome plated brass
Material housing	brass
Material seal	PTFE
Connection	female thread x male thread
Max. temperature	60 °C
Minimum medium temperature (continuous)	-10 °C
Flow	full
Pressure	5 bar

Size 3/8"

DN 10

## DIMENSIONS

Ct-1 37.3 mm

F-1 11.4 mm

F-2 11.5 mm

Lb 58,9 mm

R 80 mm

ØDf 10 mm

ØDi-1 3/8 "

ØDo-2 3/8 "

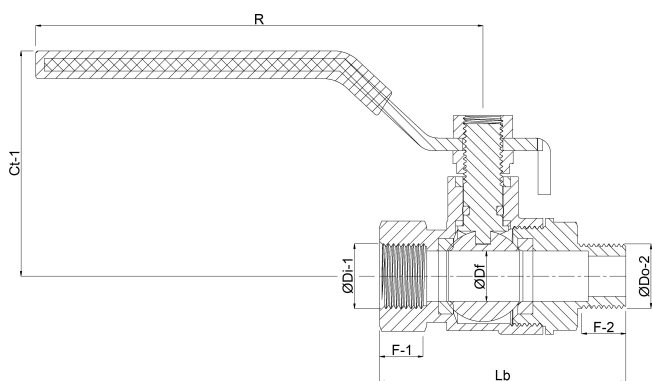

Last modified date: 07/03/2026

Bosta UK Ltd.  
Reflection House  
Olding Road  
Bury St. Edmunds  
Suffolk  
IP33 3TA  
T +44 (0) 1284 716580  
E [enquiries@bosta.co.uk](mailto:enquiries@bosta.co.uk)  
<http://www.bosta.com>