

**Profec Flange threaded steel  
zinc plated DN25 x 1" DIN  
flange x female thread DN25  
PN10/16 (1080212)**



# TECHNICAL SPECIFICATIONS

Material	steel
Surface treatment	zinc plated
Connection	DIN flange x female thread
DIN Standard	DIN 2566
Flange	PN10/16
Size	DN25 x 1"
Bolt	M12
DN	25
Diameter	33,7 mm
Outer ø	115 mm
Weight	1.1 kg
Thickness	16 mm
Bolt hole	14 mm
Holes	4

## DIMENSIONS

O	14 mm
---	-------

PCD

85 mm

ØDi-1

1 "

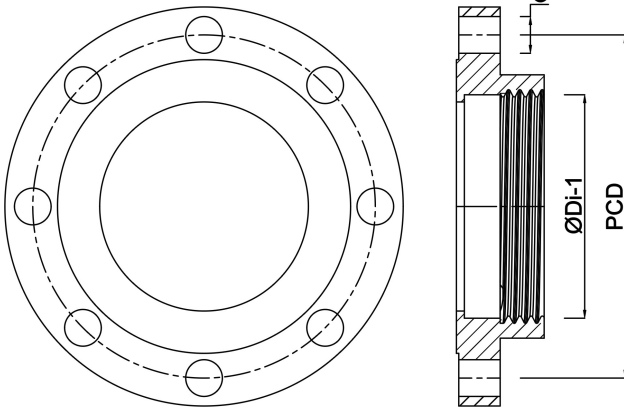

**Last modified date: 24/05/2026**

Bosta UK Ltd.  
Reflection House  
Olding Road  
Bury St. Edmunds  
Suffolk  
IP33 3TA  
T +44 (0) 1284 716580  
E [enquiries@bosta.co.uk](mailto:enquiries@bosta.co.uk)  
<http://www.bosta.com>