

**3-way ball valve T-bore PVC-U
32 mm glue socket 10bar DN25
grey type T-bore side
connection (0111521)**



TECHNICAL SPECIFICATIONS

Colour grey

Type T-bore

Material PVC-U

Operation lever

Colour lever red

Handle material PVC-U

Material housing PVC-U

Material seal PTFE/EPDM

Ball bore T-bore

Connection type side connection

Connection glue socket

Temperature range 0°C - 60°C

Pressure 10 bar

Shaft PVC

Size 32 mm

DN 25

DIMENSIONS

Ct-1 74 mm

Lb 147 mm

R 100 mm

ØDf 25 mm

ØDi-1 32 mm

ØDi-2 32 mm

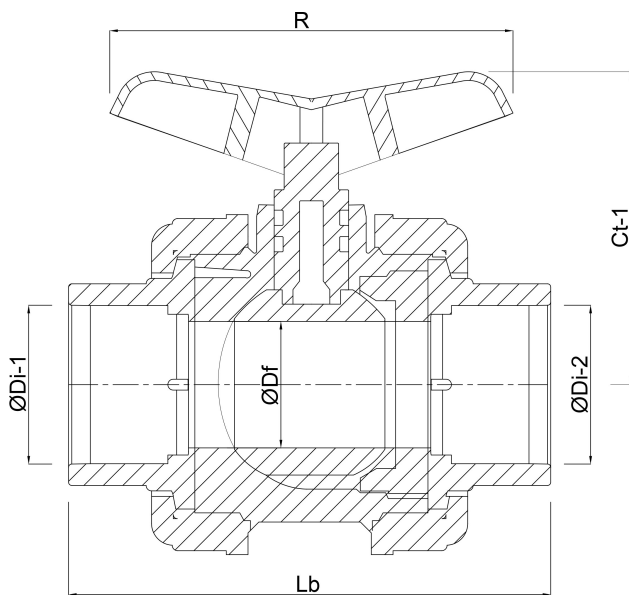

Last modified date: 23/05/2026

Bosta UK Ltd.
Reflection House
Olding Road
Bury St. Edmunds

Suffolk
IP33 3TA
T +44 (0) 1284 716580
E enquiries@bosta.co.uk
<http://www.bosta.com>