

**Drainage reducer bush rubber
reinforced with nylon 50 mm x
40 mm spigot x ring seal black
(0350397)**



TECHNICAL SPECIFICATIONS

Colour	black
Material	rubber reinforced with nylon
Connection	spigot x ring seal
Size	50 mm x 40 mm

DIMENSIONS

L 24 mm

ØDi-2 40 mm

ØDo-1 50 mm

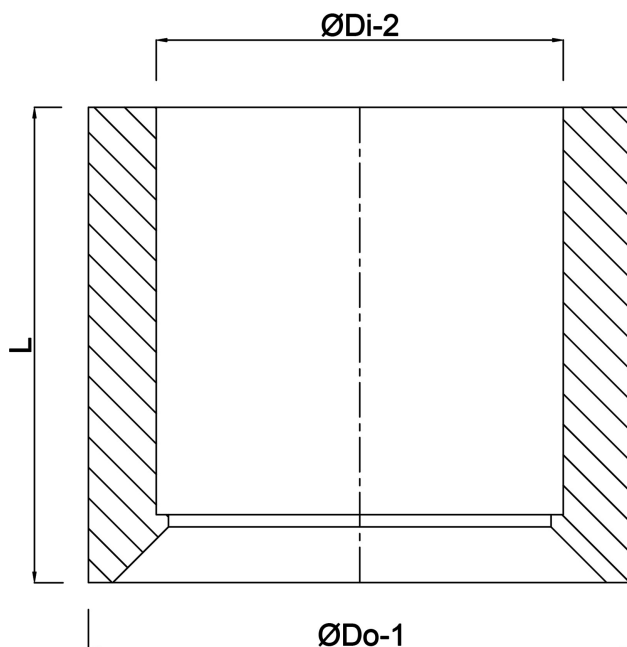

Last modified date: 23/05/2026

Bosta UK Ltd.
Reflection House
Olding Road
Bury St. Edmunds
Suffolk
IP33 3TA
T +44 (0) 1284 716580
E enquiries@bosta.co.uk
<http://www.bosta.com>