

Grundfos Multi-stage centrifugal pump stainless steel 1 1/4" 1A 400VAC type CRI 5-2 A CA I V HQQV (7039728)



GRUNDFOS 

TECHNICAL SPECIFICATIONS

Material stainless steel

Shaft stainless steel 316

Pump body stainless steel 316

Material impeller 1 stainless steel 304

Voltage 400VAC

Temperature range -20°C - 90°C

Maximum ambient temperature 40 °C

Minimum ambient temperature 0 °C

Type CRI 5-2 A CA I V HQQV

Output Power 0.5 HP

Max. head 13 m

Size 1 1/4"

Power 0.37 kW

Impellers 2

Ampere 1 A

Max flow rate 8.5 m³/h

Suction 1 1/4 "

Efficiency 73,8 %

Motor RPM 2770

DIMENSIONS

Cb-1 50 mm

Cb-2 50 mm

H-1 448 mm

L 160 mm

W-1 210 mm

ØDi-1 35 mm

ØDi-2 35 mm

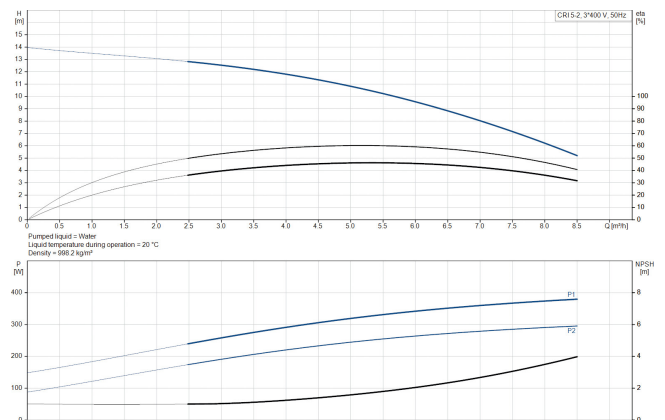
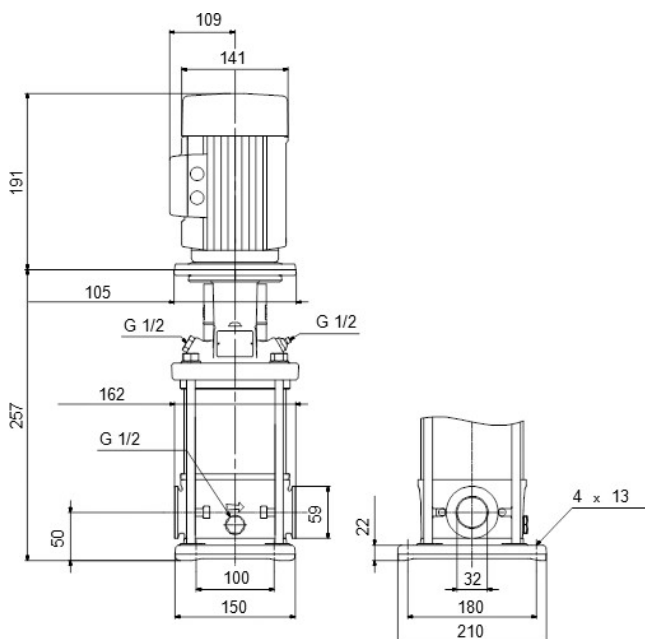

PRODUCT INFORMATION

Grundfos CRI pumps are vertical, non-self-priming, multistage, in-line, centrifugal pumps for installation in pipe systems and mounting on a foundation, suitable for industrial applications. This design provides a more compact pump design and pipework. CR pumps are designed for a variety of applications ranging from the pumping of potable water to the pumping of chemicals. The pumps are therefore suitable for a wide range of pumping systems where the performance and material of the pump meet specific demands.

Last modified date: 10/05/2026

Bosta UK Ltd.
Reflection House
Olding Road
Bury St. Edmunds
Suffolk
IP33 3TA
T +44 (0) 1284 716580
E enquiries@bosta.co.uk
<http://www.bosta.com>