

Profec Long bend 90° PVC-U 40 mm glue socket 16bar grey (0110180)



TECHNICAL SPECIFICATIONS

Colour	grey
Material	PVC-U
Connection	glue socket
Pressure	16 bar
Size	40 mm

DIMENSIONS

Cb-1	106.5 mm
Cb-2	106.5 mm
Mold	injection moulded
ØDi-1	40 mm
ØDi-2	40 mm
β	90 °

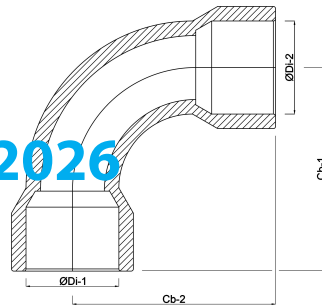

Last modified date: 13/03/2026

Bosta UK Ltd.
Reflection House
Olding Road
Bury St. Edmunds
Suffolk
IP33 3TA
T +44 (0) 1284 716580
E enquiries@bosta.co.uk
<http://www.bosta.com>