

**Profec Flange adaptor PVC-U  
DN50 x 63 mm DIN flange x  
glue socket 10bar DN50 grey  
PN10 (0111085)**



# TECHNICAL SPECIFICATIONS

Colour	grey
Material	PVC-U
Connection	DIN flange x glue socket
Size	DN50 x 63 mm
Bolt	M16
DN	50
Flange	PN10
Outer ø	165 mm
Weight	0.395 kg
Length bolt	80 mm
Thickness	18 mm
Pressure	10 bar
Bolt hole	18 mm
Holes	4

## DIMENSIONS

O	18 mm
---	-------

PCD

125 mm

ØDi-1

63 mm

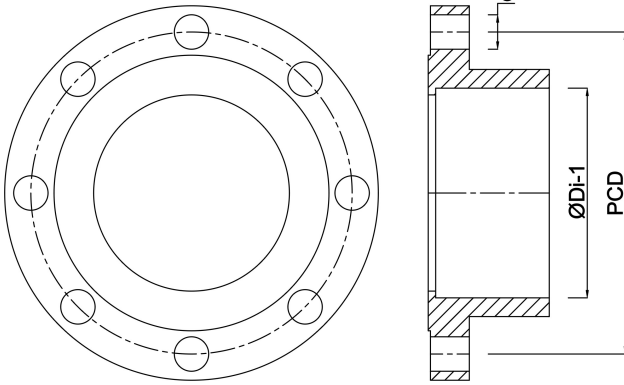

**Last modified date: 23/05/2026**

Bosta UK Ltd.  
Reflection House  
Olding Road  
Bury St. Edmunds  
Suffolk  
IP33 3TA  
T +44 (0) 1284 716580  
E [enquiries@bosta.co.uk](mailto:enquiries@bosta.co.uk)  
<http://www.bosta.com>