

VDL Ball valve PVC-U 16 mm glue socket 16bar DN10 grey type EIL viton (7018366)



VDL Van de Lande

TECHNICAL SPECIFICATIONS

Colour grey

Type EIL viton

Material PVC-U

Operation lever

Colour lever green

Handle material PVC-U

Housing construction 2-part

Material housing PVC-U

Material seal viton

Connection glue socket

Temperature range 0°C - 60°C

Pressure 16 bar

Size 16 mm

DN 10

DIMENSIONS

Ct-1 50 mm

Lb 77 mm

R 82 mm

ØDf 15 mm

ØDi-1 16 mm

ØDi-2 16 mm

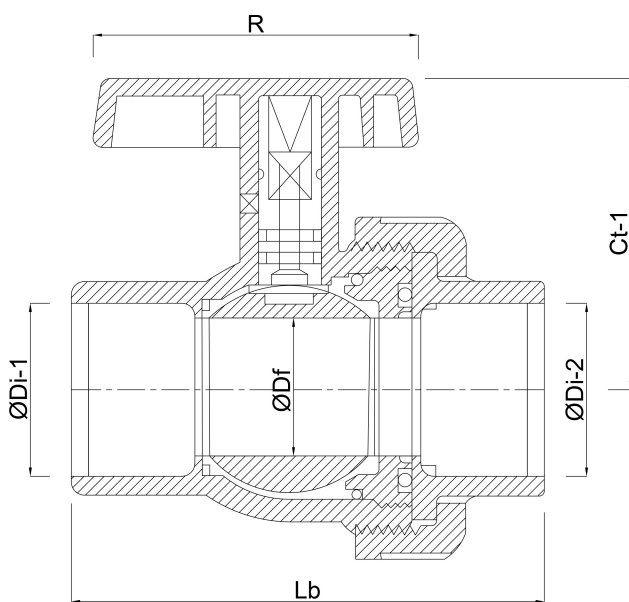

Last modified date: 25/05/2026

Bosta UK Ltd.
Reflection House
Olding Road
Bury St. Edmunds
Suffolk
IP33 3TA
T +44 (0) 1284 716580
E enquiries@bosta.co.uk
<http://www.bosta.com>