

**Profec Flange welding neck  
steel DN125 x 139,7 mm DIN  
flange x butt welding black  
PN16 (1180486)**



# TECHNICAL SPECIFICATIONS

Colour	black
Material	steel
Connection	DIN flange x butt welding
DIN Standard	DIN 2633
Flange	PN16
Size	DN125 x 139,7 mm
Outer ø	250 mm
Weight	6.07 kg
Height	55 mm
Thickness	22 mm
PCD	210 mm
Bolt hole	18 mm
Holes	8

## DIMENSIONS

O	18 mm
PCD	210 mm

ØDi-1

131.7 mm

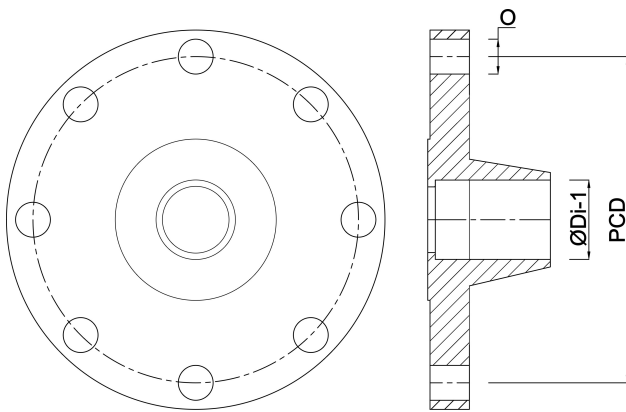

**Last modified date: 24/05/2026**

Bosta UK Ltd.  
Reflection House  
Olding Road  
Bury St. Edmunds  
Suffolk  
IP33 3TA  
T +44 (0) 1284 716580  
E [enquiries@bosta.co.uk](mailto:enquiries@bosta.co.uk)  
<http://www.bosta.com>