

**Profec Gate valve cast iron
GGG 50 epoxy coating DN300
DIN flange 16bar blue PN10
type 302 (7038250)**



TECHNICAL SPECIFICATIONS

Colour	blue
Type	302
Material	cast iron GGG 50
Surface treatment	epoxy coating
Operation	handwheel
Colour lever	blue
Handle material	cast iron
Material valve	cast iron EPDM coated
Material spindle	stainless steel
Material housing	cast iron GGG 50
Material seal	NBR
Connection	DIN flange
Max. temperature	110 °C
RAL number	RAL5017
Flange according to DIN	DIN 2501/PN10
Pressure	16 bar
Max. temp.	120 °C

Size DN300

Length 270 mm

Flange PN10

Outer ø 457 mm

PCD 400/410 mm

Holes 12

DIMENSIONS

Construction length din 3352/2c/f4

Ct-1 645 mm

L 270 mm

L 270 mm

PCD 400/410 mm

R 300 mm

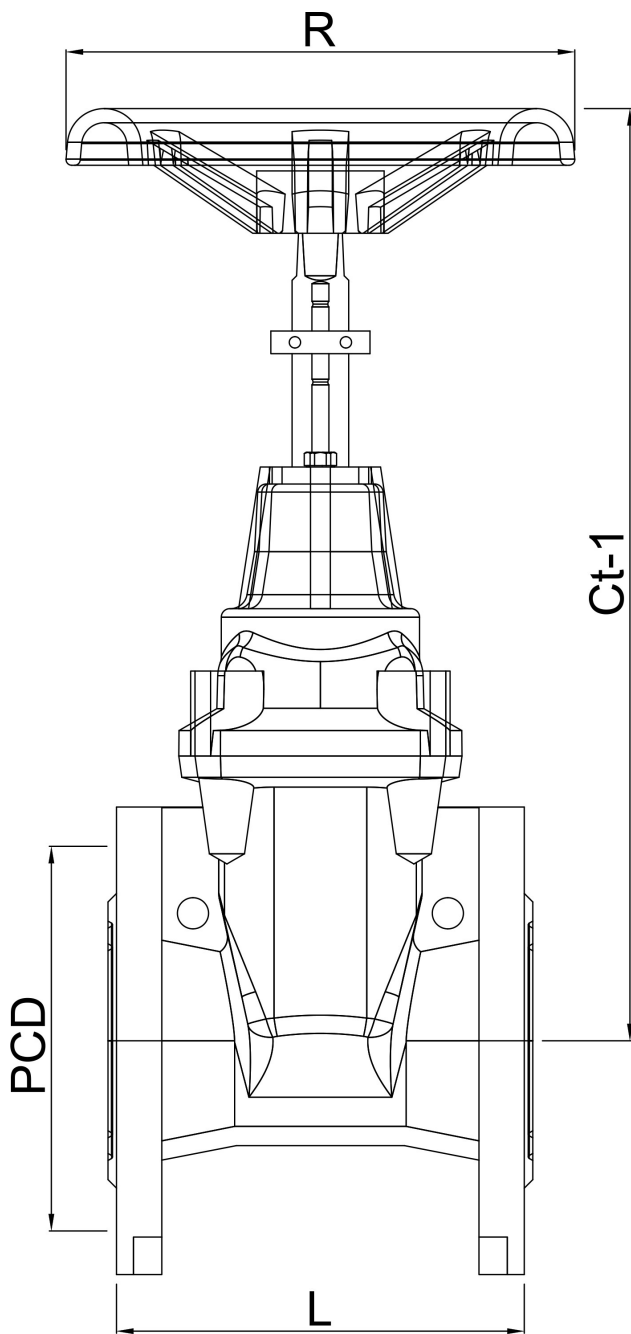

Last modified date: 27/05/2026

Bosta UK Ltd.
Reflection House
Olding Road
Bury St. Edmunds

Suffolk
IP33 3TA
T +44 (0) 1284 716580
E enquiries@bosta.co.uk
<http://www.bosta.com>