

**Profec Flange adaptor PVC-U  
DN150 x 160 mm DIN flange x  
glue socket 10bar DN150 grey  
PN10/16 (0111052)**



# TECHNICAL SPECIFICATIONS

Colour	grey
Material	PVC-U
Connection	DIN flange x glue socket
Size	DN150 x 160 mm
Bolt	M20
DN	150
Flange	PN10/16
Outer ø	285 mm
Weight	2.008 kg
Length bolt	90 mm
Thickness	30 mm
Pressure	10 bar
Bolt hole	22 mm
Holes	8

## DIMENSIONS

O	22 mm
---	-------

PCD 240 mm

ØDi-1 160 mm

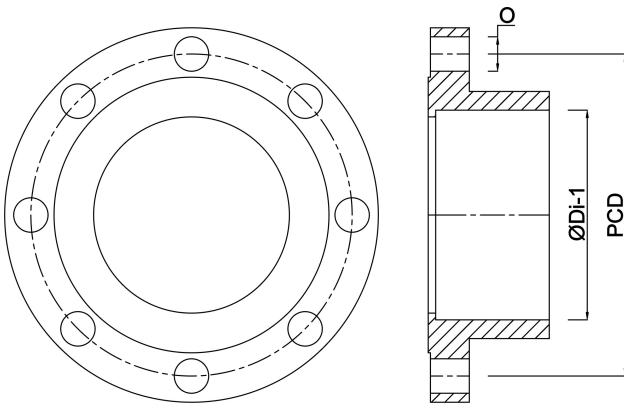

**Last modified date: 23/05/2026**

Bosta UK Ltd.  
Reflection House  
Olding Road  
Bury St. Edmunds  
Suffolk  
IP33 3TA  
T +44 (0) 1284 716580  
E [enquiries@bosta.co.uk](mailto:enquiries@bosta.co.uk)  
<http://www.bosta.com>