

**Profec Blind flange PVC-U
DN150 x 160 mm DIN flange
10bar DN150 grey PN10
(0111030)**



TECHNICAL SPECIFICATIONS

Colour	grey
Material	PVC-U
Connection	DIN flange
Size	DN150 x 160 mm
Bolt	M16
Packaging	5 pcs
DN	150
Flange	PN10
Outer ø	285 mm
Weight	1.353 kg
Length bolt	90 mm
Thickness	28 mm
Pressure	10 bar
Bolt hole	22 mm
Holes	8

DIMENSIONS

O 22 mm

PCD 240 mm

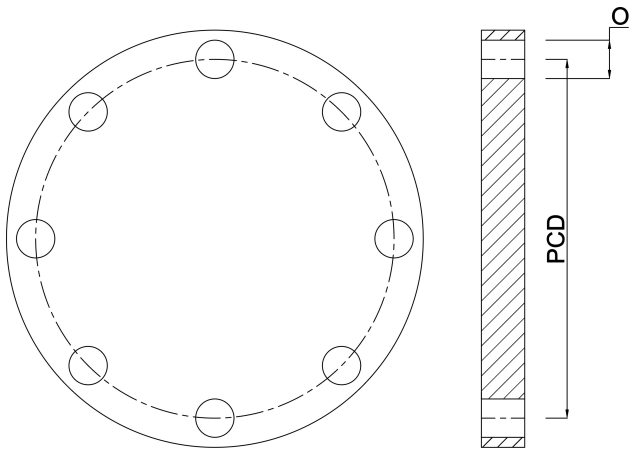

PRODUCT INFORMATION

For PCD, bolt hole size and number see Technical specifications "How to identify a flange" at the back of the catalogue (PCD equals K)

Last modified date: 23/05/2026

Bosta UK Ltd.
Reflection House
Olding Road
Bury St. Edmunds
Suffolk
IP33 3TA
T +44 (0) 1284 716580
E enquiries@bosta.co.uk
<http://www.bosta.com>