

**Profec 1-piece Ball valve
stainless steel 316 1/2" female
thread 69bar light (0090894)**



TECHNICAL SPECIFICATIONS

Material stainless steel 316

Operation lever

Colour lever blue

Handle material stainless steel

Housing construction 1-part

Model light

Material housing stainless steel 304

Material seal PTFE

Connection female thread

Gasket PTFE

Flow reduced

Temperature range -10°C - 150°C

Pressure 69 bar

Size 1/2"

Length 56,5 mm

DIMENSIONS

Ct-1 39 mm

F-1 14 mm

F-2 14 mm

Lb 55 mm

R 93 mm

ØDf 9 mm

ØDi-1 1/2 "

ØDi-2 1/2 "

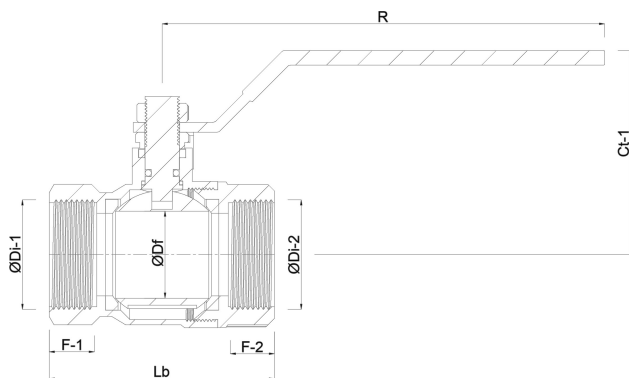

Last modified date: 22/05/2026

Bosta UK Ltd.
Reflection House
Olding Road
Bury St. Edmunds
Suffolk
IP33 3TA
T +44 (0) 1284 716580
E enquiries@bosta.co.uk
<http://www.bosta.com>