

**Profec Swing check valve with
lifting device ductile iron
(GGG40) epoxy coating DN200
DIN flange 16bar DN200 blue
PN10 (0402640)**



TECHNICAL SPECIFICATIONS

Colour	blue
Material	ductile iron (GGG40)
Surface treatment	epoxy coating
Material cover	ductile iron
Material housing	ductile iron (GGG40)
Material seal	NBR
Connection	DIN flange
Gasket	NBR
Temperature range	0°C - 80°C
Pressure	16 bar
Capacity	685 m ³ /h
Size	DN200
Length	500 mm
DN	200
Flange	PN10
Outer ø	340 mm
PCD	295 mm

DIMENSIONS

Ct-1 170 mm

L 500 mm

PCD 295 mm

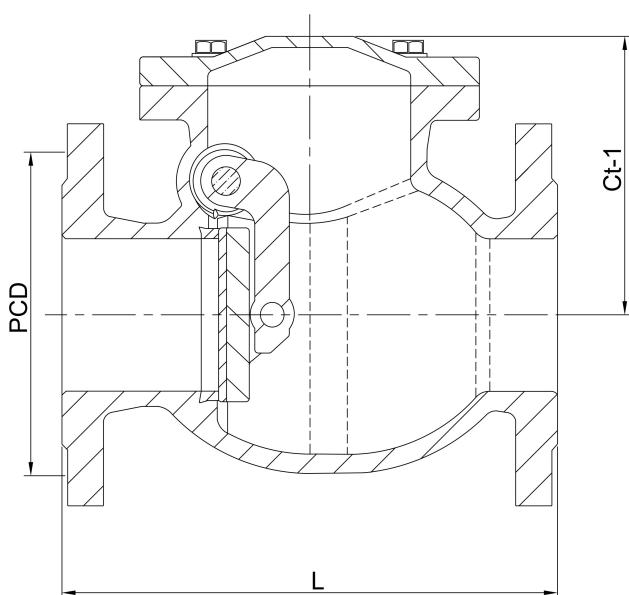

Last modified date: 23/05/2026

Bosta UK Ltd.
Reflection House
Olding Road
Bury St. Edmunds
Suffolk
IP33 3TA
T +44 (0) 1284 716580
E enquiries@bosta.co.uk
<http://www.bosta.com>