

Profec Flange flat steel DN100 x 108,0 mm DIN flange x butt welding 10bar PN10 (1180241)



TECHNICAL SPECIFICATIONS

Material	steel
Connection	DIN flange x butt welding
DIN Standard	DIN 2576
Flange	PN10
Pressure	10 bar
Size	DN100 x 108,0 mm
Inner ø	109,6 mm
Outer ø	220 mm
Weight	4.17 kg
Thickness	20 mm
PCD	180 mm
Bolt hole	18 mm
Holes	8

DIMENSIONS

O	18 mm
PCD	180 mm

ØDi-1

109.6 mm

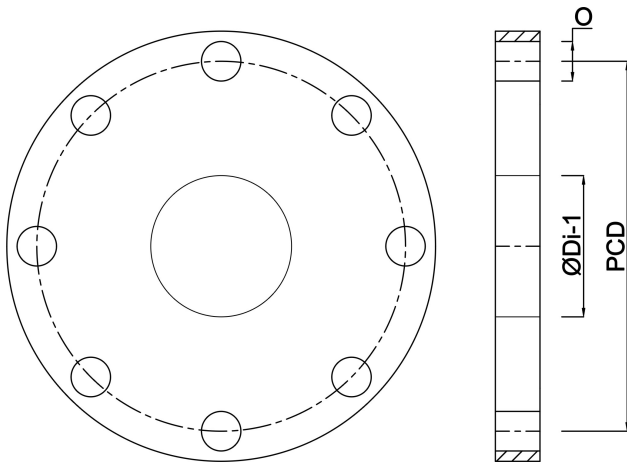

Last modified date: 24/05/2026

Bosta UK Ltd.
Reflection House
Olding Road
Bury St. Edmunds
Suffolk
IP33 3TA
T +44 (0) 1284 716580
E enquiries@bosta.co.uk
<http://www.bosta.com>