

Profec Flange flat steel DN50 x 60,3 mm DIN flange x butt welding 10bar PN10 (1180235)



TECHNICAL SPECIFICATIONS

Material	steel
Connection	DIN flange x butt welding
DIN Standard	DIN 2576
Flange	PN10
Pressure	10 bar
Size	DN50 x 60,3 mm
Inner ø	61,1 mm
Outer ø	165 mm
Weight	2.46 kg
Thickness	18 mm
PCD	125 mm
Bolt hole	18 mm
Holes	4

DIMENSIONS

O	18 mm
PCD	125 mm

ØDi-1

61.1 mm

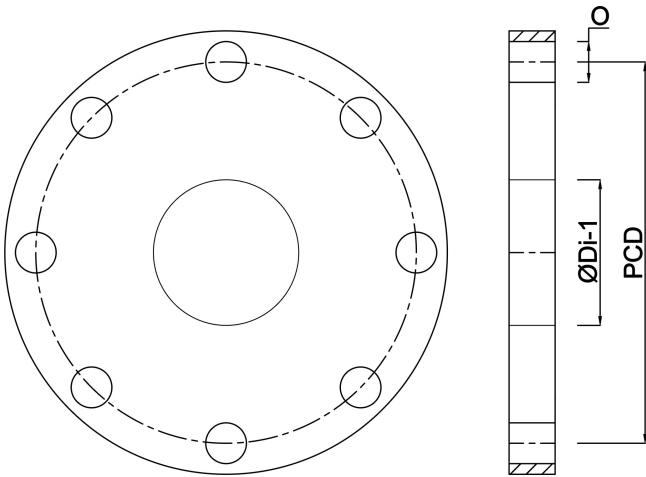

Last modified date: 14/03/2026

Bosta UK Ltd.
Reflection House
Olding Road
Bury St. Edmunds
Suffolk
IP33 3TA
T +44 (0) 1284 716580
E enquiries@bosta.co.uk
<http://www.bosta.com>