

**Profec Nr. 40 Bend 45° cast iron
galvanised 3/4" female thread
x male thread 25bar DVGW
(1004004)**



TECHNICAL SPECIFICATIONS

Material	cast iron
Surface treatment	galvanised
Approval	DVGW
Connection	female thread x male thread
Fitting nr.	Nr. 40
Temperature range	-20°C - 120°C
Pressure	25 bar
Size	3/4"

DIMENSIONS

Cb-1	43 mm
Cb-2	43 mm
F-1	18 mm
F-2	18 mm
ØDi-1	3/4 "
ØDo-2	3/4 "
β	45 °

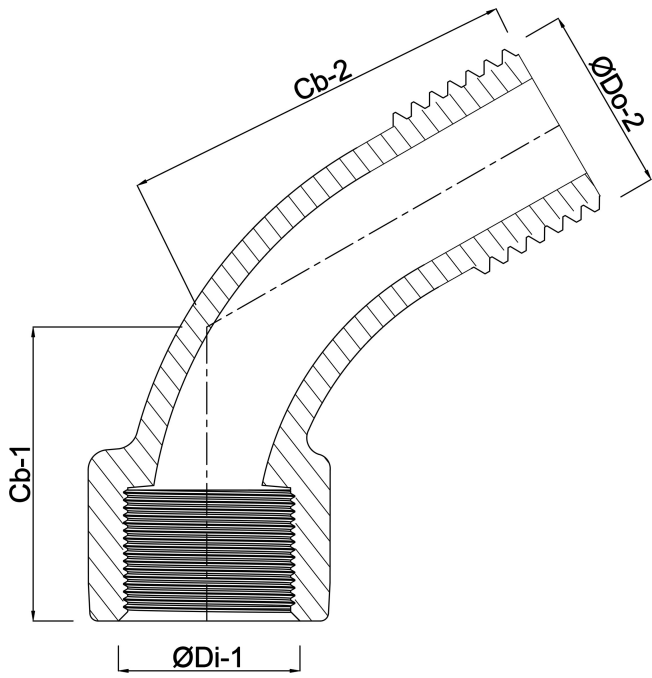

Last modified date: 13/03/2026

Bosta UK Ltd.
Reflection House
Olding Road
Bury St. Edmunds
Suffolk
IP33 3TA
T +44 (0) 1284 716580
E enquiries@bosta.co.uk
<http://www.bosta.com>