

**Hydro-S Butterfly valve PVC-U
200/225 mm flange 10bar
DN200 grey PN10 type 7500
(7014385)**



hydro-s

TECHNICAL SPECIFICATIONS

Colour grey

Type 7500

Material PVC-U

Operation lever

Colour lever blue

Material valve PVC-U

Material spindle steel

Material housing PP GF

Material seal EPDM

Connection flange

Flange PN10

Temperature range 0°C - 40°C

Size 200/225 mm

DN 200

Width 75 mm

Pressure 10 bar

Bolt hole 24 mm

DIMENSIONS

Ct-1 256 mm

PCD 295 mm

R 335 mm

W-1 75 mm

W-2 115 mm

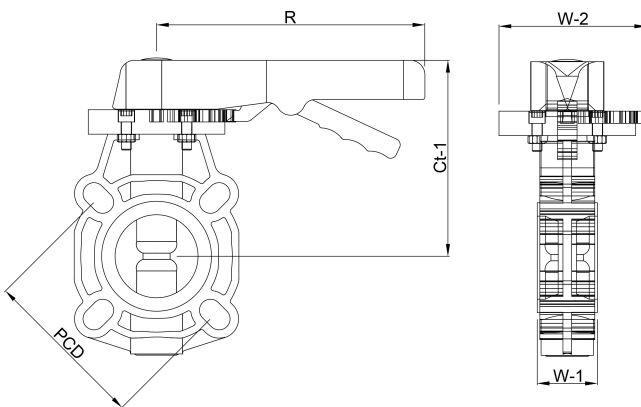

Last modified date: 09/03/2026

Bosta UK Ltd.
Reflection House
Olding Road
Bury St. Edmunds
Suffolk
IP33 3TA
T +44 (0) 1284 716580
E enquiries@bosta.co.uk
<http://www.bosta.com>