

**Drainage reducer bush rubber  
reinforced with nylon 75 mm x  
50 mm spigot x ring seal black  
(0350398)**



# TECHNICAL SPECIFICATIONS

|            |                              |
|------------|------------------------------|
| Colour     | black                        |
| Material   | rubber reinforced with nylon |
| Connection | spigot x ring seal           |
| Size       | 75 mm x 50 mm                |

## DIMENSIONS

|       |       |
|-------|-------|
| L     | 46 mm |
| ØDi-2 | 50 mm |
| ØDo-1 | 75 mm |

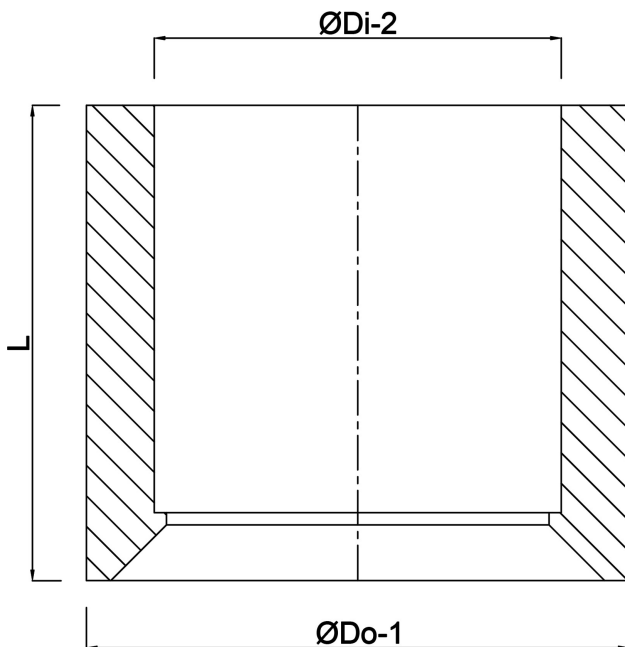

**Last modified date: 23/05/2026**

Bosta UK Ltd.  
Reflection House  
Olding Road  
Bury St. Edmunds  
Suffolk  
IP33 3TA  
T +44 (0) 1284 716580  
E [enquiries@bosta.co.uk](mailto:enquiries@bosta.co.uk)  
<http://www.bosta.com>