

**Profec Butterfly valve ductile
iron (GGG40) epoxy coating
DN80 flange 10bar DN80 blue
PN6/10/16 type 601 disc
stainless steel 316 (0401867)**



TECHNICAL SPECIFICATIONS

Colour	blue
Type	601
Material	ductile iron (GGG40)
Surface treatment	epoxy coating
Operation	lever
Colour lever	black
Handle material	malleable cast iron
Material valve	stainless steel 304
Material spindle	stainless steel 316
Seat material	EPDM
Material housing	ductile iron (GGG40)
Material seal	EPDM
Connection	flange
DIN Standard	DIN 2501
Flange	PN6/10/16
Temperature range	0°C - 90°C
Pressure	10 bar

Size DN80

DN 80

Width 45 mm

Height 313 mm

Torque 17 Nm

DIMENSIONS

Construction length din 3202 k1, iso 5752

Ct-1 209 mm

PCD 150/160 mm

R 260 mm

W-1 45 mm

W-2 90 mm

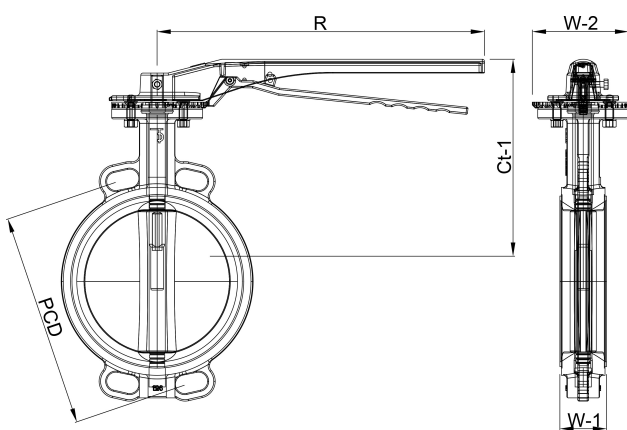

Last modified date: 23/05/2026

Bosta UK Ltd.
Reflection House
Olding Road
Bury St. Edmunds
Suffolk
IP33 3TA
T +44 (0) 1284 716580
E enquiries@bosta.co.uk
<http://www.bosta.com>