

**Profec Butterfly valve ductile
iron (GGG40) epoxy coating
DN125 flange 10bar DN125
blue PN6/10/16 type 601 disc
stainless steel 316 (0401869)**



TECHNICAL SPECIFICATIONS

Colour	blue
Type	601
Material	ductile iron (GGG40)
Surface treatment	epoxy coating
Operation	lever
Colour lever	black
Handle material	malleable cast iron
Material valve	stainless steel 304
Material spindle	stainless steel 316
Seat material	EPDM
Material housing	ductile iron (GGG40)
Material seal	EPDM
Connection	flange
DIN Standard	DIN 2501
Flange	PN6/10/16
Temperature range	0°C - 90°C
Pressure	10 bar

Size DN125

DN 125

Width 54 mm

Height 377 mm

Torque 35 Nm

DIMENSIONS

Construction length din 3202 k1, iso 5752

Ct-1 241 mm

PCD 200/210 mm

R 260 mm

W-1 54 mm

W-2 108 mm

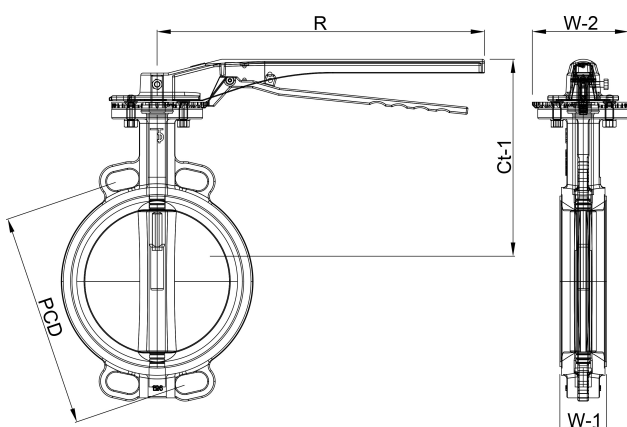

Last modified date: 23/05/2026

Bosta UK Ltd.
Reflection House
Olding Road
Bury St. Edmunds
Suffolk
IP33 3TA
T +44 (0) 1284 716580
E enquiries@bosta.co.uk
<http://www.bosta.com>