

**Profec Flange adaptor PVC-U
DN32 x 40 mm DIN flange x
glue socket 10bar DN32 grey
PN10 (0111083)**



TECHNICAL SPECIFICATIONS

Colour	grey
Material	PVC-U
Connection	DIN flange x glue socket
Size	DN32 x 40 mm
Bolt	M16
DN	32
Flange	PN10
Outer ø	140 mm
Weight	0.237 kg
Length bolt	70 mm
Thickness	15 mm
Pressure	10 bar
Bolt hole	18 mm
Holes	4

DIMENSIONS

O	18 mm
---	-------

PCD 100 mm

ØDi-1 40 mm

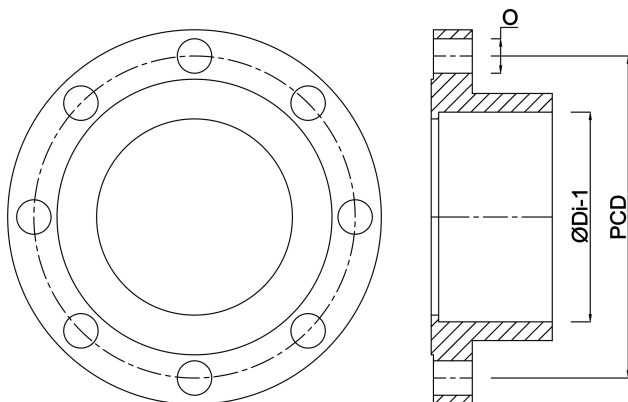

Last modified date: 23/05/2026

Bosta UK Ltd.
Reflection House
Olding Road
Bury St. Edmunds
Suffolk
IP33 3TA
T +44 (0) 1284 716580
E enquiries@bosta.co.uk
<http://www.bosta.com>