

**Flange PP DN65 x 2 1/2" DIN
flange x female thread 6bar
DN65 black PN10/16 type
reinforced (0707206)**



TECHNICAL SPECIFICATIONS

Colour	black
Type	reinforced
Material	PP
Material seal	rubber reinforced with nylon
Connection	DIN flange x female thread
Flange	PN10/16
Thickness	18 mm
Bolt hole	18 mm
Size	DN65 x 2 1/2"
Packaging	65 pcs
DN	65
Outer ø	195 mm
Pressure	6 bar
Holes	4

DIMENSIONS

O	18 mm
---	-------

PCD

145 mm

ØDi-1

2 1/2 "

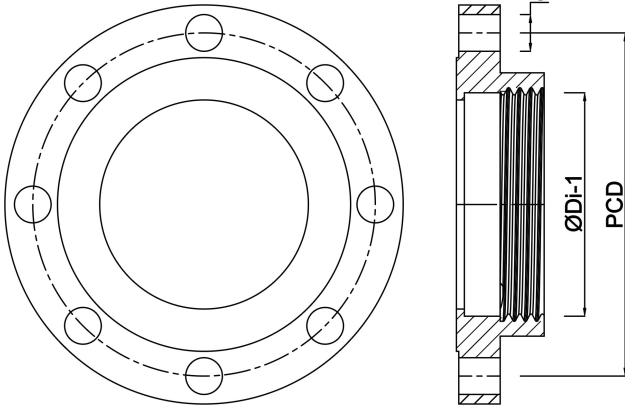

Last modified date: 24/05/2026

Bosta UK Ltd.
Reflection House
Olding Road
Bury St. Edmunds
Suffolk
IP33 3TA
T +44 (0) 1284 716580
E enquiries@bosta.co.uk
<http://www.bosta.com>