

**Foras Centrifugal pump cast
iron 2" x 1 1/4" female thread
8bar 9,6A 400/690VAC blue
type KM 550/1 T (0920265)**

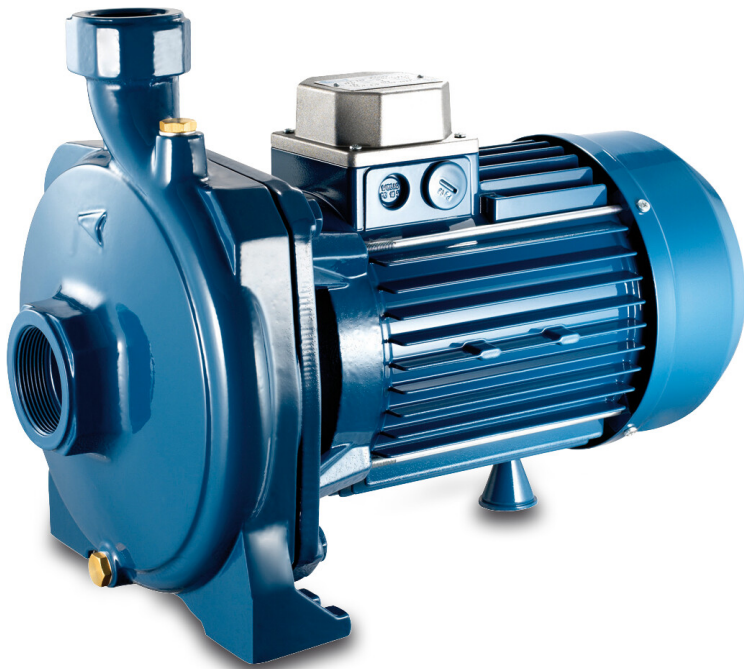

FOROS
WATER PUMPS

TECHNICAL SPECIFICATIONS

Colour blue

Material cast iron

Material impeller 1 brass

Connection female thread

Seal type C

Length 425 mm

Voltage 400/690VAC

Max. temperature 90 °C

Width 250 mm

Minimum medium temperature 0 °C
(continuous)

Height 323 mm

Press 1 1/4 "

Maximum ambient temperature 40 °C

Suction 2 "

Minimum ambient temperature 0 °C

Type KM 550/1 T

Output Power	5,5 HP
--------------	--------

Max. head	56,5 m
-----------	--------

Size	2" x 1 1/4"
------	-------------

Power	4 kW
-------	------

Max flow rate	21 m ³ /h
---------------	----------------------

BEP Capacity	19
--------------	----

BEP Head	47
----------	----

Efficiency	58 %
------------	------

DIMENSIONS

Cb-1	133 mm
------	--------

Cr-1	54 mm
------	-------

G-1	190 mm
-----	--------

H	323 mm
---	--------

H	323 mm
---	--------

L	425 mm
---	--------

Lb	108 mm
----	--------

W-1	240 mm
-----	--------

W-2	250 mm
-----	--------

ØDi-1

2 "

ØDi-2

1 1/4 "

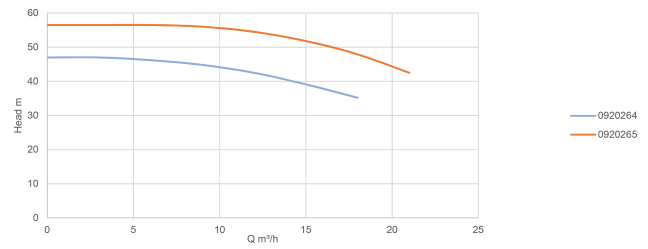
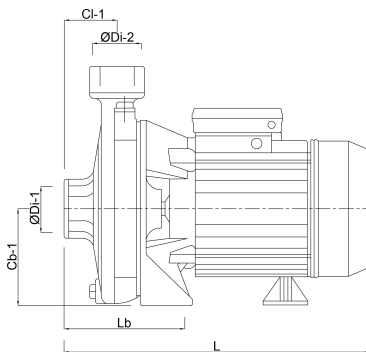

PRODUCT INFORMATION

Mechanical seal.

Oversized self-lubricating bearings.

Sealed motor with external cooling.

Electrical winding Class F Condenser - thermo - amperometric safety (only in mono).

The maximum water temperature is 90°C.

Last modified date: 24/05/2026

Bosta UK Ltd.

Reflection House

Olding Road

Bury St. Edmunds

Suffolk

IP33 3TA

T +44 (0) 1284 716580

E enquiries@bosta.co.uk

<http://www.bosta.com>