

**Profec Flange threaded steel
zinc plated DN40 x 1 1/2" DIN
flange x female thread DN40
PN10/16 (1080214)**



TECHNICAL SPECIFICATIONS

Material	steel
Surface treatment	zinc plated
Connection	DIN flange x female thread
DIN Standard	DIN 2566
Flange	PN10/16
Size	DN40 x 1 1/2"
Bolt	M16
DN	40
Diameter	48,3 mm
Outer ø	150 mm
Weight	1.78 kg
Thickness	16 mm
Bolt hole	18 mm
Holes	4

DIMENSIONS

O	18 mm
---	-------

PCD 110 mm

ØDi-1 1 1/2 "

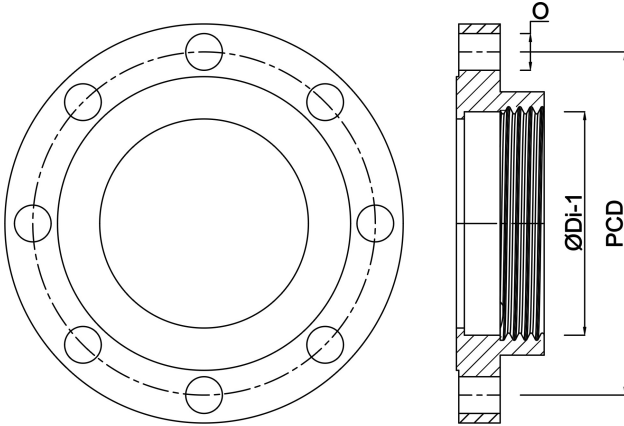

Last modified date: 24/05/2026

Bosta UK Ltd.
Reflection House
Olding Road
Bury St. Edmunds
Suffolk
IP33 3TA
T +44 (0) 1284 716580
E enquiries@bosta.co.uk
<http://www.bosta.com>