

**Profec Gate valve cast iron  
GGG 50 epoxy coating DN80  
DIN flange 16bar blue PN10/16  
type 302 (7038244)**



# TECHNICAL SPECIFICATIONS

Colour	blue
Type	302
Material	cast iron GGG 50
Surface treatment	epoxy coating
Operation	handwheel
Colour lever	blue
Handle material	cast iron
Material valve	cast iron EPDM coated
Material spindle	stainless steel
Material housing	cast iron GGG 50
Material seal	NBR
Connection	DIN flange
Max. temperature	110 °C
RAL number	RAL5017
Flange according to DIN	DIN 2501/PN10
Pressure	16 bar
Max. temp.	120 °C

Size	DN80
Length	180 mm
Flange	PN10/16
Outer ø	198 mm
PCD	160 mm
Holes	8

## DIMENSIONS

Construction length	din 3352/2c/f4
Ct-1	253 mm
L	180 mm
L	180 mm
PCD	160 mm
R	180 mm

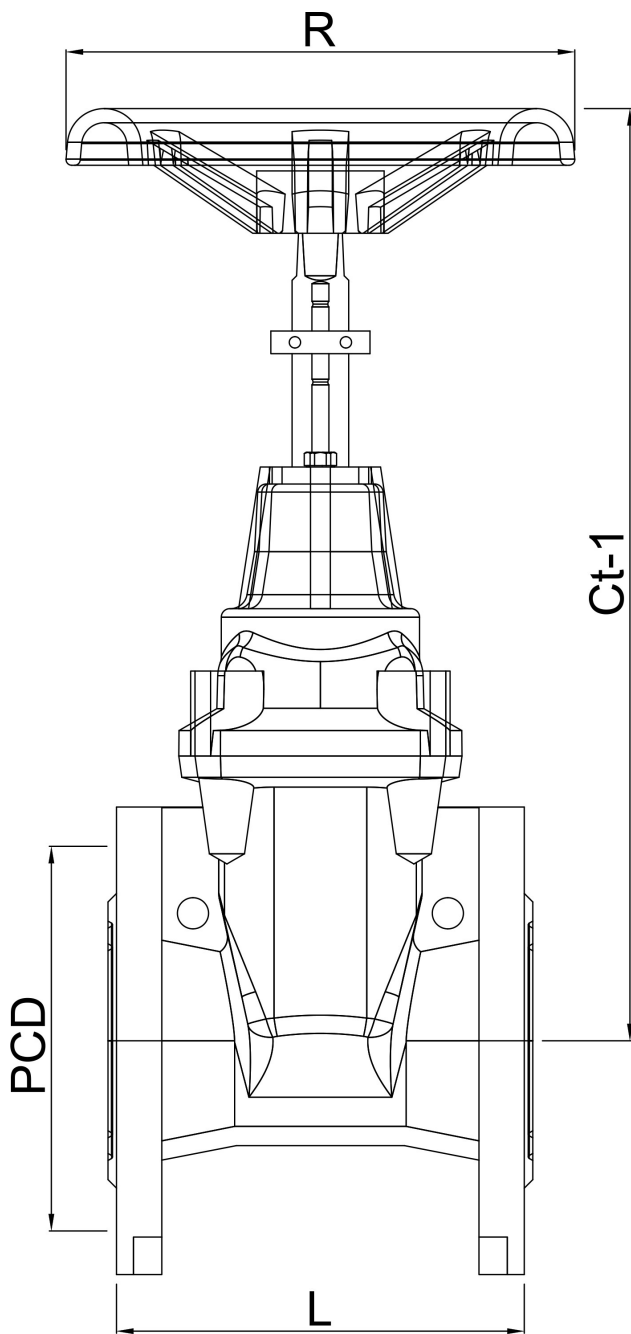

**Last modified date: 27/05/2026**

Bosta UK Ltd.  
Reflection House  
Olding Road  
Bury St. Edmunds

Suffolk  
IP33 3TA  
T +44 (0) 1284 716580  
E [enquiries@bosta.co.uk](mailto:enquiries@bosta.co.uk)  
<http://www.bosta.com>