

**Profec Flange threaded steel
DN25 x 1" DIN flange x female
thread 16bar black PN10/16
(1180212)**



TECHNICAL SPECIFICATIONS

Colour	black
Material	steel
Connection	DIN flange x female thread
DIN Standard	DIN 2566
Flange	PN10/16
Pressure	16 bar
Size	DN25 x 1"
Diameter	33,7 mm
Outer ø	115 mm
Weight	1.1 kg
Height	24 mm
Thickness	16 mm
PCD	85 mm
Bolt hole	14 mm
Holes	4

DIMENSIONS

O 14 mm

PCD 85 mm

ØDi-1 1 "

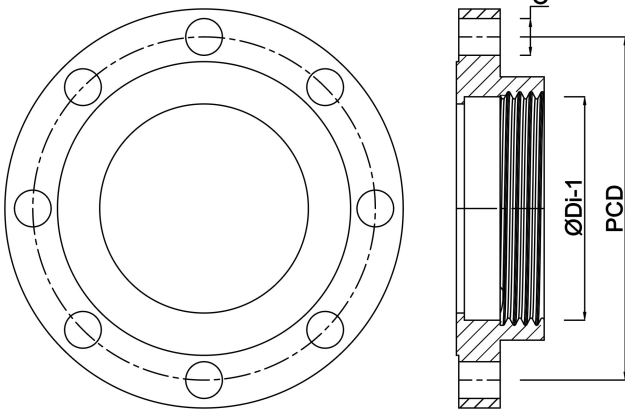

Last modified date: 24/05/2026

Bosta UK Ltd.
Reflection House
Olding Road
Bury St. Edmunds
Suffolk
IP33 3TA
T +44 (0) 1284 716580
E enquiries@bosta.co.uk
<http://www.bosta.com>