

Profec Flange flat steel DN150 x 168,3 mm DIN flange x butt welding 10bar PN10 (1180240)



TECHNICAL SPECIFICATIONS

Material	steel
Connection	DIN flange x butt welding
DIN Standard	DIN 2576
Flange	PN10
Pressure	10 bar
Size	DN150 x 168,3 mm
Inner ø	170,5 mm
Outer ø	285 mm
Weight	6.55 kg
Thickness	22 mm
PCD	240 mm
Bolt hole	22 mm
Holes	8

DIMENSIONS

O	22 mm
PCD	240 mm

ØDi-1

170.5 mm

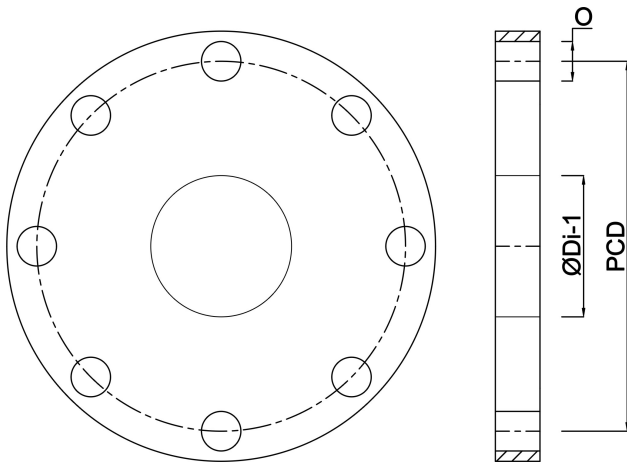

Last modified date: 24/05/2026

Bosta UK Ltd.
Reflection House
Olding Road
Bury St. Edmunds
Suffolk
IP33 3TA
T +44 (0) 1284 716580
E enquiries@bosta.co.uk
<http://www.bosta.com>