

Waterco Commercial pool pump 90 mm glue socket 5,2A 400VAC black type Hydrostar MKIV 400 (7035699)



WATERCO
EUROPE LTD
Water, the liquid of life

TECHNICAL SPECIFICATIONS

Colour black

Material seal carbon steel

Connection glue socket

Voltage 400VAC

Width 288 mm

Height 428 mm

IP value IP55

Type Hydrostar MKIV 400

Capacity 61 m³/h

Output Power 4 HP

Size 90 mm

Length 846 mm

Max. temperature 40 °C

Weight 41 kg

Power 3 kW

Ampere 5,2 A

Frequency 50 Hz

Motor RPM

2890

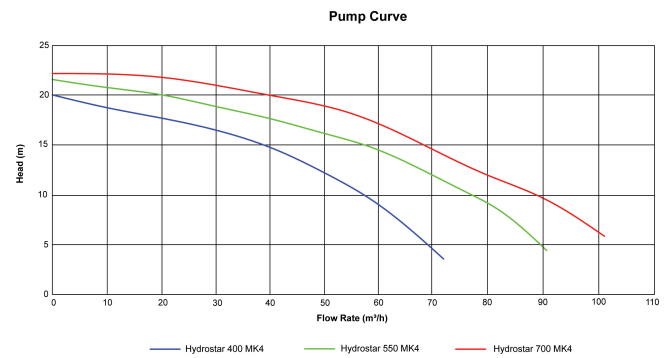
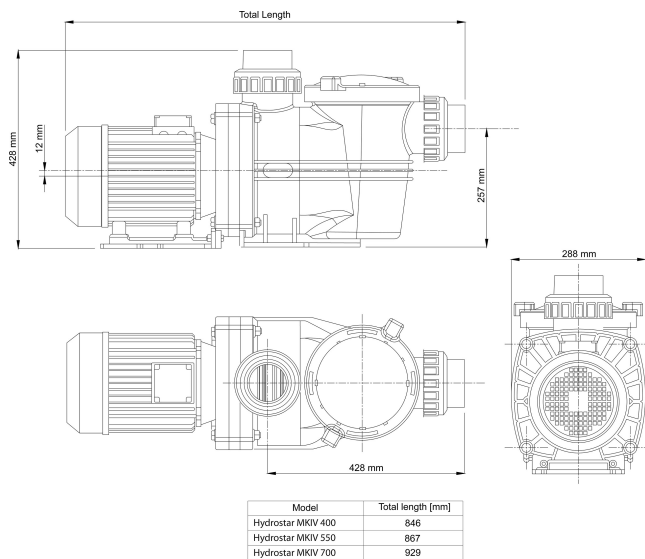

PRODUCT INFORMATION

The Hydrostar MKIV has been designed to provide a substantially quieter operation with even higher flow rates and higher head than the previous Hydrostar models. Waterco has optimised the pump's hydraulic efficiency by reshaping its internal profile.

Features:

- 3" port supplied with 3" imperial & 90mm metric quick connect unions
- 6L hair and lint pot
- Transparent pump lid for easy inspection of the strainer basket
- Quarter turn lid and lock ring with easy grip handles
- High grade mechanical seal
- Carbon/graphite with 316 stainless steel
- Heavy duty IP33 weather proofed motor with stainless steel shaft
- Hydraulically efficient internal volute
- Drain plugs
- Integral support base for ease of mounting
- UV stabilised glass filled thermoplastic pump body

Last modified date: 10/03/2026

Bosta UK Ltd.
Reflection House
Olding Road
Bury St. Edmunds
Suffolk
IP33 3TA
T +44 (0) 1284 716580
E enquiries@bosta.co.uk
<http://www.bosta.com>