

VDL Flange adaptor PVC-U 200 mm glue socket 10bar DN175 grey PN10 type A (7002896)



VL Van de Lande

TECHNICAL SPECIFICATIONS

Colour grey

Material PVC-U

DIN Standard DIN 2501

Flange PN10

Pressure 10 bar

Type A

Size 200 mm

Connection glue socket

Packaging 3 pcs

DN 175

Outer ø 106 mm

Thickness 36 mm

Bolt hole 22 mm

Holes 8

DIMENSIONS

O 22 mm

PCD 270 mm

ØDi-1 200 mm

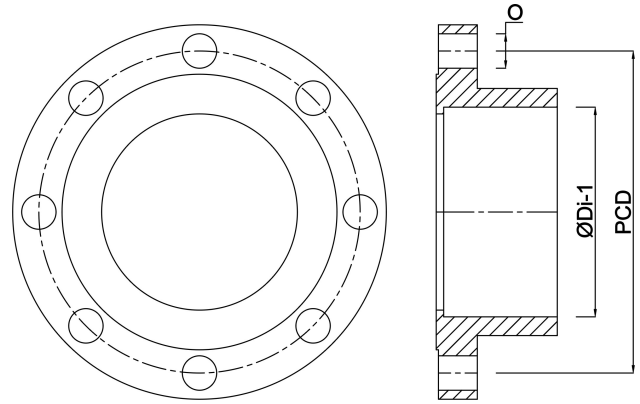

Last modified date: 24/05/2026

Bosta UK Ltd.
Reflection House
Olding Road
Bury St. Edmunds
Suffolk
IP33 3TA
T +44 (0) 1284 716580
E enquiries@bosta.co.uk
<http://www.bosta.com>