

**DAB Submersible pump  
stainless steel 304 2" female  
thread 1,64A 380VAC stainless  
steel type Feka VS 550 T-NA  
(7043951)**



# TECHNICAL SPECIFICATIONS

Colour stainless steel

Material stainless steel 304

Pump body stainless steel 304

Material impeller 1 stainless steel 304

Connection female thread

Max. temperature 50 °C

Minimum medium temperature 0 °C  
(continuous)

Press 2 "

Maximum ambient temperature 40 °C

Minimum ambient temperature 0 °C

Type Feka VS 550 T-NA

Size 2"

Float not included

Voltage 380VAC

Ampere 1,64 A

# DIMENSIONS

Cb-1 98 mm

Db 170 mm

H 172 mm

L 492 mm

W-1 203 mm

ØDi-1 2"

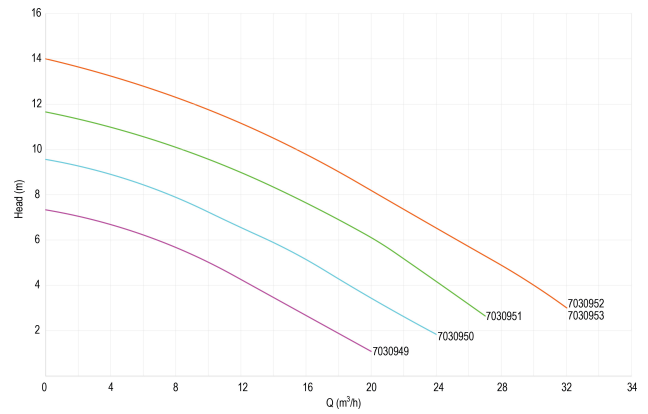
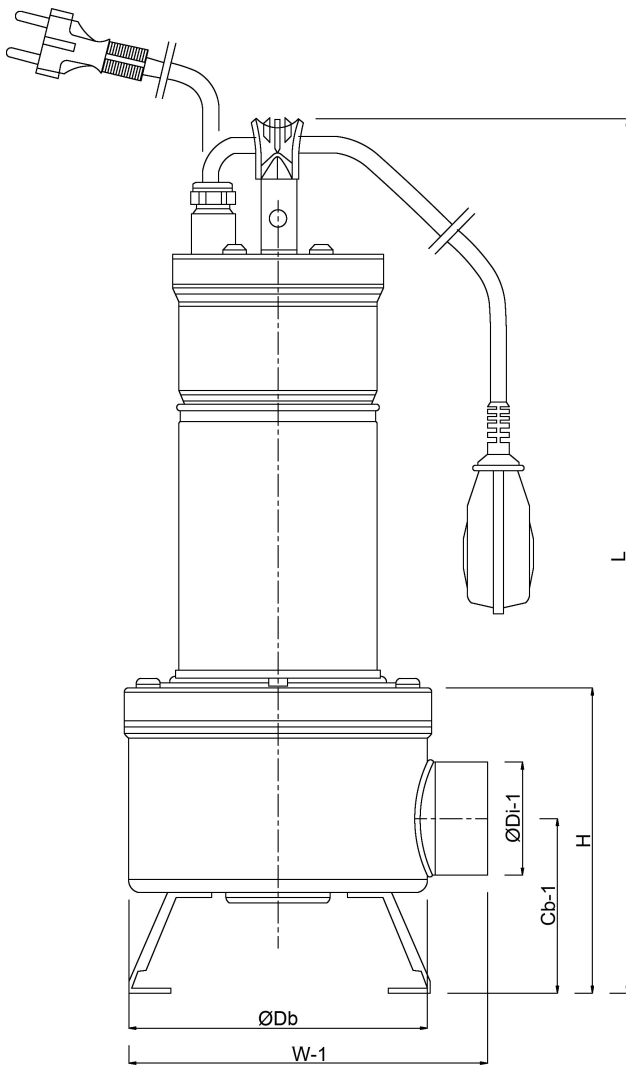

## PRODUCT INFORMATION

Power cable: 10 metre H07RN-F, with plug for the single-phase version.

Installation: fixed or portable, vertical position.

Maximum immersion depth: 7 metre

Suitable for residential waste water as sewage containing solid matter with size up to 50 mm.

**Last modified date: 26/05/2026**

Bosta UK Ltd.  
Reflection House  
Olding Road  
Bury St. Edmunds  
Suffolk  
IP33 3TA  
T +44 (0) 1284 716580  
E [enquiries@bosta.co.uk](mailto:enquiries@bosta.co.uk)  
<http://www.bosta.com>