

**Drainage reducer T-piece 45°
PVC-U 160 mm x 125 mm x 160
mm SN4 ring seal grey
KOMO/BENOR (0360277)**



TECHNICAL SPECIFICATIONS

Colour	grey
Material	PVC-U
Approval	KOMO/BENOR
Connection	ring seal
Size	160 mm x 125 mm x 160 mm
SN	SN4

DIMENSIONS

Cr-1	231 mm
Ct-1	240 mm
L	323 mm
ØDi-1	160 mm
ØDi-2	125 mm
ØDi-3	160 mm
β	45 °

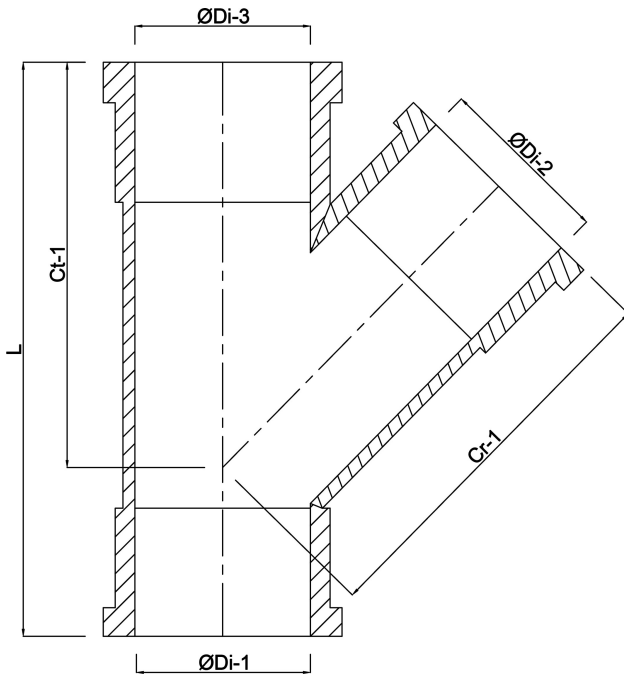

Last modified date: 23/05/2026

Bosta UK Ltd.
Reflection House
Olding Road
Bury St. Edmunds
Suffolk
IP33 3TA
T +44 (0) 1284 716580
E enquiries@bosta.co.uk
<http://www.bosta.com>