

**Profec Blind flange PVC-U
DN125 x 140 mm DIN flange
16bar DN125 grey PN10/16
(0111029)**



TECHNICAL SPECIFICATIONS

Colour	grey
Material	PVC-U
Connection	DIN flange
Size	DN125 x 140 mm
Bolt	M16
Packaging	5 pcs
DN	125
Flange	PN10/16
Outer ø	250 mm
Weight	1.144 kg
Length bolt	90 mm
Thickness	26 mm
Pressure	16 bar
Bolt hole	18 mm
Holes	8

DIMENSIONS

O 18 mm

PCD 210 mm

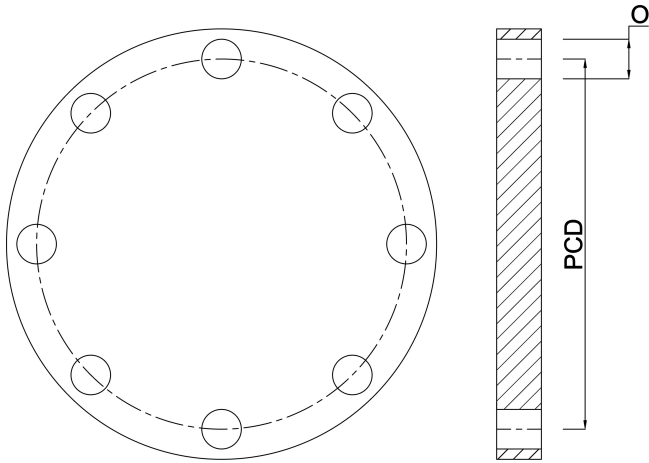

PRODUCT INFORMATION

For PCD, bolt hole size and number see Technical specifications "How to identify a flange" at the back of the catalogue (PCD equals K)

Last modified date: 13/03/2026

Bosta UK Ltd.
Reflection House
Olding Road
Bury St. Edmunds
Suffolk
IP33 3TA
T +44 (0) 1284 716580
E enquiries@bosta.co.uk
<http://www.bosta.com>