

**Profec 1-piece Ball valve
stainless steel 316 1 1/2"
female thread 69bar light
(0090898)**



TECHNICAL SPECIFICATIONS

Material stainless steel 316

Operation lever

Colour lever blue

Handle material stainless steel

Housing construction 1-part

Model light

Material housing stainless steel 304

Material seal PTFE

Connection female thread

Gasket PTFE

Flow reduced

Temperature range -10°C - 150°C

Pressure 69 bar

Size 1 1/2"

Length 83 mm

DIMENSIONS

Ct-1	70 mm
F-1	16.8 mm
F-2	16.8 mm
Lb	81 mm
R	140 mm
ØDf	25 mm
ØDi-1	1 1/2 "
ØDi-2	1 1/2 "

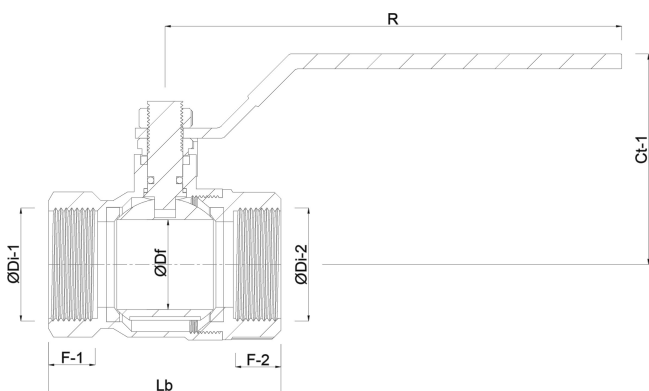

Last modified date: 06/03/2026

Bosta UK Ltd.
 Reflection House
 Olding Road
 Bury St. Edmunds
 Suffolk
 IP33 3TA
 T +44 (0) 1284 716580
 E enquiries@bosta.co.uk
<http://www.bosta.com>