

Itap Ball valve brass nickel plated 1/4" female thread 5bar DVGW type 066 (0401079)



TECHNICAL SPECIFICATIONS

Type 066

Material brass

Surface treatment nickel plated

Approval DVGW

Operation lever

Colour lever yellow

Handle material steel

Housing construction 2-part

Ball material hard chrome plated brass

Material housing brass

Material seal PTFE

Connection female thread

Max. temperature 60 °C

Minimum medium temperature -10 °C
(continuous)

Flow full

Pressure 5 bar

Size 1/4"

DIMENSIONS

Ct-1 37.3 mm

F-1 11 mm

F-2 11 mm

Lb 49,5 mm

R 80 mm

ØDf 10 mm

ØDi-1 1/4 "

ØDi-2 1/4 "

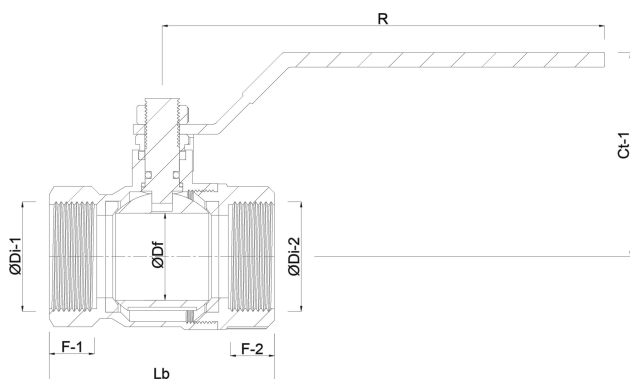

Last modified date: 23/05/2026

Bosta UK Ltd.
Reflection House

Olding Road
Bury St. Edmunds
Suffolk
IP33 3TA
T +44 (0) 1284 716580
E enquiries@bosta.co.uk
<http://www.bosta.com>