

**Profec Blind flange PVC-U
DN50 x 63 mm DIN flange
16bar DN50 grey PN10/16
(0111024)**



TECHNICAL SPECIFICATIONS

Colour	grey
Material	PVC-U
Connection	DIN flange
Size	DN50 x 63 mm
Bolt	M16
Packaging	30 pcs
DN	50
Flange	PN10/16
Outer ø	165 mm
Weight	0.358 kg
Length bolt	80 mm
Thickness	18 mm
Pressure	16 bar
Bolt hole	18 mm
Holes	4

DIMENSIONS

O 18 mm

PCD 126 mm

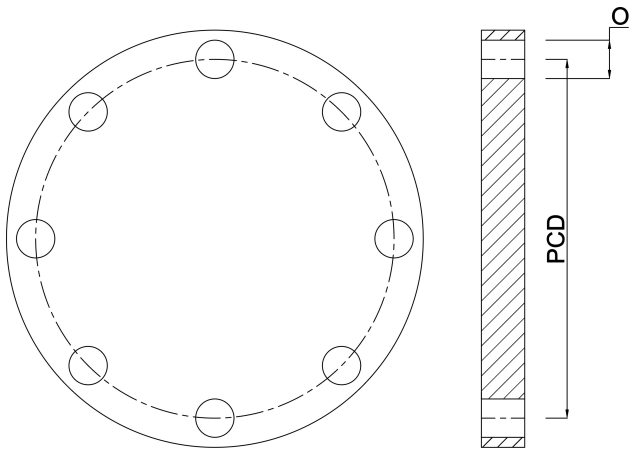

PRODUCT INFORMATION

For PCD, bolt hole size and number see Technical specifications "How to identify a flange" at the back of the catalogue (PCD equals K)

Last modified date: 23/05/2026

Bosta UK Ltd.
Reflection House
Olding Road
Bury St. Edmunds
Suffolk
IP33 3TA
T +44 (0) 1284 716580
E enquiries@bosta.co.uk
<http://www.bosta.com>