

**Flange stainless steel 316  
DN40 x 48,3 mm DIN flange x  
butt welding 10bar DN40  
PN10/40 (0080634)**



# TECHNICAL SPECIFICATIONS

Material stainless steel 316

Connection DIN flange x butt welding

DIN Standard DIN 2576

Pressure 10 bar

Size DN40 x 48,3 mm

DN 40

Inner ø 49,5 mm

Flange PN10/40

Diameter 48,3 mm

Outer ø 150 mm

Weight 2.1 kg

Thickness 18 mm

Bolt hole 18 mm

Holes 4

## DIMENSIONS

O 18 mm

PCD 110 mm

ØDi-1 49.5 mm

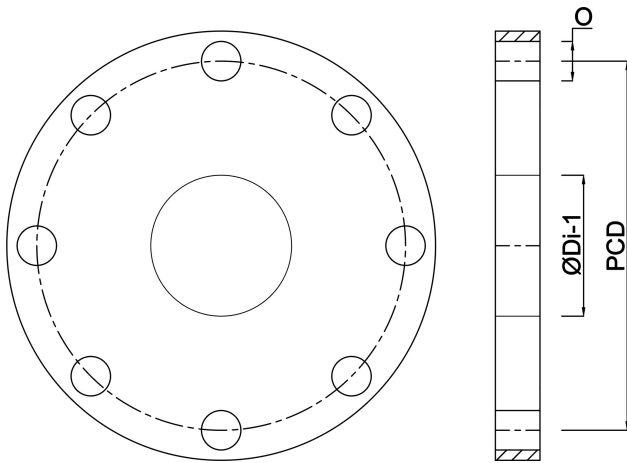

**Last modified date: 22/05/2026**

Bosta UK Ltd.  
Reflection House  
Olding Road  
Bury St. Edmunds  
Suffolk  
IP33 3TA  
T +44 (0) 1284 716580  
E [enquiries@bosta.co.uk](mailto:enquiries@bosta.co.uk)  
<http://www.bosta.com>