

**Profec Flange PVC-U DN15 x
1/2" DIN flange x female thread
16bar DN15 grey PN10/16
(0111160)**



TECHNICAL SPECIFICATIONS

Colour	grey
Material	PVC-U
Connection	DIN flange x female thread
Flange	PN10/16
Pressure	16 bar
Size	DN15 x 1/2"
DN	15
Outer ø	95 mm
Weight	0.077 kg
Thickness	11 mm
Bolt hole	14 mm
Holes	4

DIMENSIONS

O	14 mm
PCD	65 mm
ØDi-1	1/2 "

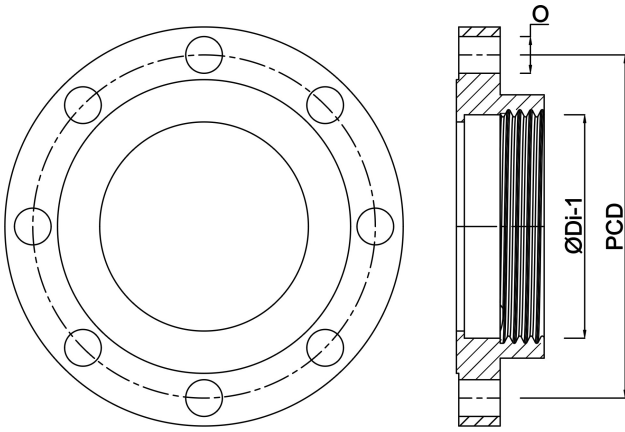

Last modified date: 23/05/2026

Bosta UK Ltd.
Reflection House
Olding Road
Bury St. Edmunds
Suffolk
IP33 3TA
T +44 (0) 1284 716580
E enquiries@bosta.co.uk
<http://www.bosta.com>