

**Profec Butterfly valve ductile  
iron (GGG40) epoxy coating  
DN65 flange 10bar DN65 blue  
PN6/10/16 type 601 disc  
stainless steel 316 (0401866)**



# TECHNICAL SPECIFICATIONS

Colour	blue
Type	601
Material	ductile iron (GGG40)
Surface treatment	epoxy coating
Operation	lever
Colour lever	black
Handle material	malleable cast iron
Material valve	stainless steel 304
Material spindle	stainless steel 316
Seat material	EPDM
Material housing	ductile iron (GGG40)
Material seal	EPDM
Connection	flange
DIN Standard	DIN 2501
Flange	PN6/10/16
Temperature range	0°C - 90°C
Pressure	10 bar

Size DN65

DN 65

Width 45 mm

Height 300 mm

Torque 12 Nm

## DIMENSIONS

Construction length din 3202 k1, iso 5752

Ct-1 202 mm

PCD 130/145 mm

R 260 mm

W-1 45 mm

W-2 90 mm

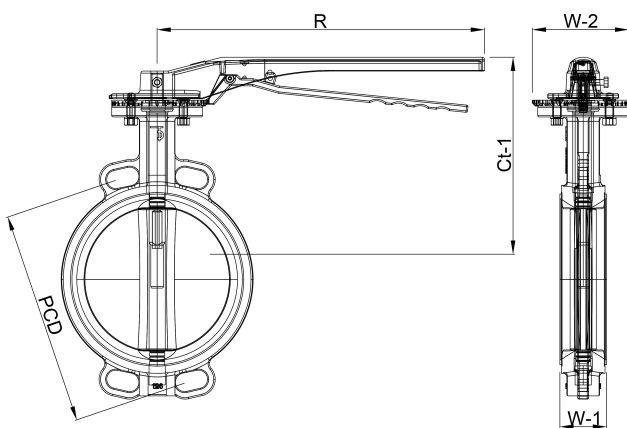

**Last modified date: 23/05/2026**

Bosta UK Ltd.  
Reflection House  
Olding Road  
Bury St. Edmunds  
Suffolk  
IP33 3TA  
T +44 (0) 1284 716580  
E [enquiries@bosta.co.uk](mailto:enquiries@bosta.co.uk)  
<http://www.bosta.com>