

**Profec Nr. 301 Round cap cast
iron galvanised 1/4" female
thread 25bar DVGW (1030102)**



TECHNICAL SPECIFICATIONS

Material	cast iron
Surface treatment	galvanised
Approval	DVGW
Connection	female thread
Fitting nr.	Nr. 301
Temperature range	-20°C - 120°C
Pressure	25 bar
Size	1/4"

DIMENSIONS

F-1	9 mm
H	15 mm
ØDi-1	1/4 "

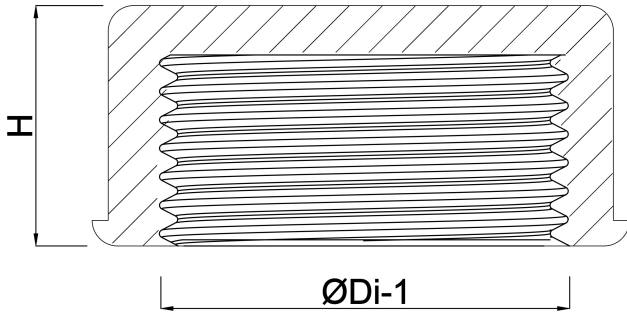

Last modified date: 24/05/2026

Bosta UK Ltd.
Reflection House
Olding Road
Bury St. Edmunds
Suffolk
IP33 3TA
T +44 (0) 1284 716580
E enquiries@bosta.co.uk
<http://www.bosta.com>