

**DAB Submersible pump
stainless steel 304 2" female
thread 8,63A 230VAC stainless
steel type Feka VS 1200 M-NA
(7043950)**



TECHNICAL SPECIFICATIONS

Colour stainless steel

Material stainless steel 304

Pump body stainless steel 304

Material impeller 1 stainless steel 304

Connection female thread

Max. temperature 50 °C

Minimum medium temperature 0 °C
(continuous)

Press 2 "

Maximum ambient temperature 40 °C

Minimum ambient temperature 0 °C

Type Feka VS 1200 M-NA

Size 2"

Float not included

Voltage 230VAC

Ampere 8,63 A

DIMENSIONS

Cb-1 98 mm

Db 170 mm

H 172 mm

L 492 mm

W-1 203 mm

ØDi-1 2"

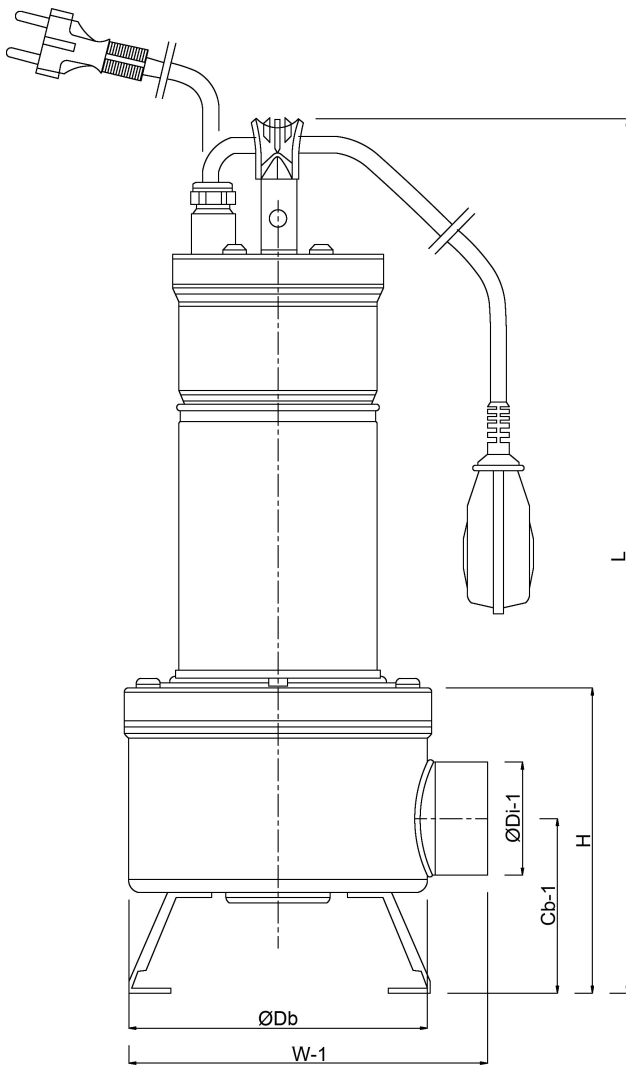

PRODUCT INFORMATION

Power cable: 10 metre H07RN-F, with plug for the single-phase version.

Installation: fixed or portable, vertical position.

Maximum immersion depth: 7 metre

Suitable for residential waste water as sewage containing solid matter with size up to 50 mm.

Last modified date: 26/05/2026

Bosta UK Ltd.
Reflection House
Olding Road
Bury St. Edmunds
Suffolk
IP33 3TA
T +44 (0) 1284 716580
E enquiries@bosta.co.uk
<http://www.bosta.com>