

# Waterco Commercial sand filter fibreglass 3"/90mm flange 4bar grey type SPDD1050 (7038379)



**WATERCO**  
EUROPE LTD  
Water, the liquid of life

# TECHNICAL SPECIFICATIONS

Colour grey

Material fibreglass

Connection flange

Pressure 4 bar

Max. temp. 40 °C

Type SPDD1050

Capacity 26 m<sup>3</sup>/h

Size 3"/90mm

Sand 1485 kg

Filter area 0.87 m<sup>2</sup>

Max. pool vol. 100 m<sup>3</sup>

# DIMENSIONS

B 1110 mm

C 2270 mm

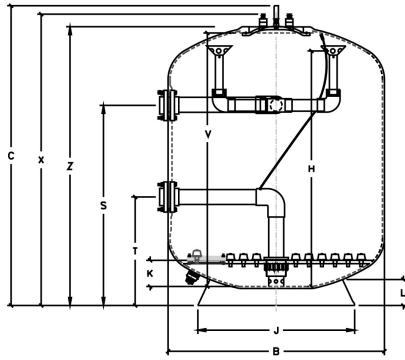

PART NO.	MODEL	FLANGE SIZE	B mm	C mm	K mm	V mm	H mm	L mm	X mm	Z mm	J mm	X mm	T mm	
7038379	SPDD1050	90	3"	1110	2270	220	1950	1620	176	2185	2115	1045	1450	750
7038380	SPDD1200	90	3"	1229	2243	150	1900	1750	176	2158	2088	1045	1449	749
7038381	SPDD1400	110	4"	1442	2313	200	1975	1800	218	2228	2158	1202	1514	814
7038382	SPDD1600	110	4"	1644	2285	200	1950	1800	218	2200	2130	1202	1525	828
7038383	SPDD1800	160	6"	1839	2260	320	2010	1920	315	2175	2105	1755	1489	789
7038384	SPDD2000	160	6"	2042	2368	320	2100	1920	345	2313	2243	1755	1489	789
7038385	SPDD2200	160	6"	2245	2415	380	2090	1980	345	2330	2260	1755	1386	803
7038386	SPDD2350	160	6"	2390	2438	355	2118	1955	340	2330	2330	2037	1550	850
7038387	SPDD2500	160	6"	2575	2510	355	2190	1955	340	2405	2405	2037	1484	1011

## PRODUCT INFORMATION

Micron SPDD filters are fitted with a plate and nozzle system, which ensures uniform flow for both filtering and backwashing, ensuring maximum performance through the media bed. The nozzle plate system also allows the introduction of pressurised air directly into the bottom of the filter media. Uniform introduction of air and water through the nozzle plate provides vigorous agitation and filter media bed expansion required for an effective air/water backwash leading to reduced backwashing times and reduced volumes of water. Save up to 25% of backwash water.

Features:

- 1.2m bed depth
- Ultra smooth bobbin finish
- Flanged connections
- Nozzle plate system

**Last modified date: 27/05/2026**

Bosta UK Ltd.  
Reflection House  
Olding Road  
Bury St. Edmunds  
Suffolk  
IP33 3TA

T +44 (0) 1284 716580  
E [enquiries@bosta.co.uk](mailto:enquiries@bosta.co.uk)  
<http://www.bosta.com>