

**Flotide Pool pump 50 mm / 1
1/2" metric/imperial glue
socket 1,5A 230VAC black type
SS 020 UK plug with RCD plug
(7030252)**



FLOTIDE

TECHNICAL SPECIFICATIONS

Colour	black
Shaft	stainless steel 316
Material seal	stainless steel 316
Connection	metric/imperial glue socket
Type	UK plug
Voltage	230VAC
Max. temperature	40 °C
Width	211 mm
Height	340 mm
Frequency	50 Hz
IP value	IPX5
Type	SS 020
Capacity	8,4 m ³ /h
Output Power	0,2 HP
Max. head	4 m
Size	50 mm / 1 1/2"
Length	507 mm

Weight 6.2 kg

Power 0.28 kW

Ampere 1,5 A

Noise level 55 dB

BEP Capacity 8

BEP Head 2.5

DIMENSIONS

A 507 mm

B 211 mm

C 340 mm

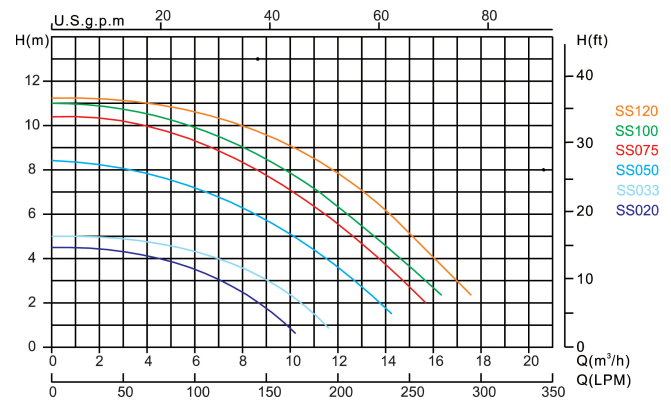
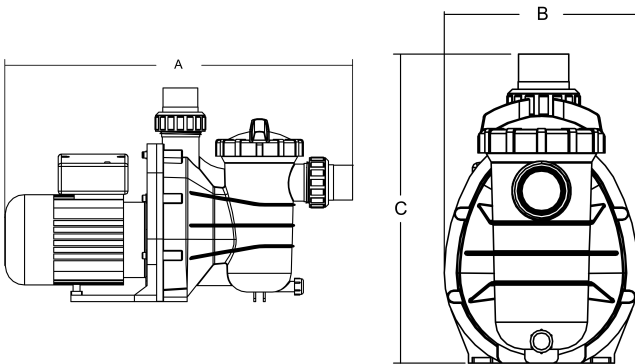

PRODUCT INFORMATION

This pump is designed for medium sized domestic swimming pools. Low energy consumption, quiet running.

Features:

- Connection: metric / imperial glue socket
- Transparent lid for easy checking
- NSK bearing
- Insulation: Class B
- IP55 protection
- Built in thermal protection
- Supplied including metric & imperial unions
- Supplied with RCD differential plug
- UK 3-pin plug included

Last modified date: 08/05/2026

Bosta UK Ltd.
Reflection House
Olding Road
Bury St. Edmunds
Suffolk
IP33 3TA
T +44 (0) 1284 716580
E enquiries@bosta.co.uk
<http://www.bosta.com>